



INSTRUCTION MANUAL

FM TRANSCEIVER

IC-V85 IC-V85-T

This device complies with Part 15 of the FCC Rules. Operation is subject to the following two conditions: (1) this device may not cause harmful interference, and (2) this device must accept any interference received, including interference that may cause undesired operation.

Icom Inc.



FOREWORD

Thank you for purchasing this Icom transceiver. The IC-V85 FM TRANSCEIVER is designed and built with Icom's superior technology and craftsmanship. With proper care, this transceiver should provide you with years of trouble-free operation.

We want to take a couple of moments of your time to thank you for making the IC-V85 your radio of choice, and hope you agree with Icom's philosophy of "technology first." Many hours of research and development went into the design of your IC-V85.

◇ **FEATURES**

- 7 W*— *high transmit output power*
*7 W : IC-V85 except [THA] version,
5.5 W : IC-V85 [THA] version
- CTCSS and DTCS encoder/decoder standard
- Optional DTMF decoder

IMPORTANT

READ ALL INSTRUCTIONS carefully and completely before using the transceiver.

SAVE THIS INSTRUCTION MANUAL— This instruction manual contains important operating instructions for the IC-V85.

EXPLICIT DEFINITIONS

WORD	DEFINITION
⚠ WARNING!	Personal injury, fire hazard or electric shock may occur.
CAUTION	Equipment damage may occur.
NOTE	Recommended for optimum use. No risk of personal injury, fire or electric shock.

Icom, Icom Inc. and the ICOM logo are registered trademarks of Icom Incorporated (Japan) in the United States, the United Kingdom, Germany, France, Spain, Russia and/or other countries.

PRECAUTIONS

⚠ WARNING RF EXPOSURE! This device emits Radio Frequency (RF) energy. Extreme caution should be observed when operating this device. If you have any questions regarding RF exposure and safety standards please refer to the Federal Communications Commission Office of Engineering and Technology's report on Evaluating Compliance with FCC Guidelines for Human Radio frequency Electromagnetic Fields (OET Bulletin 65)

⚠ WARNING! NEVER hold the transceiver so that the antenna is very close to, or touching exposed parts of the body, especially the face or eyes, while transmitting. The transceiver will perform best if the microphone is 5 to 10 cm (2 to 4 inches) away from the lips and the transceiver is vertical.

⚠ WARNING! NEVER operate the transceiver with a headset or other audio accessories at high volume levels. Hearing experts advise against continuous high volume operation. If you experience a ringing in your ears, reduce the volume or discontinue use.

⚠ WARNING! NEVER operate the transceiver while driving a vehicle. Safe driving requires your full attention—anything less may result in an accident.

⚠ WARNING! NEVER connect the transceiver to an AC outlet. This may pose a fire hazard or result in an electric shock.

NEVER connect a power supply of more than 16 V DC through the optional CP-19R CIGARETTE LIGHTER CABLE to the [DC 11V] jack to prevent damaging the transceiver.

NEVER connect the transceiver to a power source using reverse polarity. This will ruin the transceiver.

NEVER cut the DC power cable between the DC plug and fuse holder. If an incorrect connection is made after cutting, the transceiver may be damaged.

NEVER expose the transceiver to rain, snow or any liquids. The transceiver may be damaged.

NEVER operate or touch the transceiver with wet hands. This may result in an electric shock or ruin the transceiver.

NEVER attempt to charge alkaline or dry cell batteries. Be aware that external DC power connections will charge batteries inside the battery case. This will damage not only the battery case but also the transceiver.

DO NOT push the PTT when not actually desiring to transmit.

PRECAUTIONS—continued

DO NOT operate the transceiver near unshielded electrical blasting caps or in an explosive atmosphere.

BE CAREFUL! The transceiver will become hot when operating it continuously for long periods.

AVOID using or placing the transceiver in direct sunlight or in areas with temperatures below -10°C ($+14^{\circ}\text{F}$) or above $+60^{\circ}\text{C}$ ($+140^{\circ}\text{F}$).

Place the unit in a secure place to avoid inadvertent use by children.

AVOID the use of chemical agents such as benzine or alcohol when cleaning, as they can damage the transceiver's surfaces.

Even when the transceiver power is OFF, a slight current still flows in the circuits. Remove the battery pack or case from the transceiver when not using it for a long time. Otherwise, the battery pack (Li-Ion: BP-227) or installed batteries will become exhausted.

For USA only:

Caution: Changes or modifications to this transceiver, not expressly approved by Icom Inc., could void your authority to operate this transceiver under FCC regulations.

SUPPLIED ACCESSORIES

① Antenna*	1
② Hand strap*	1
③ 2251 OPT sheet*	1
④ Battery pack*/Battery case*	1
⑤ Belt clip* (with screws)	1
⑥ AC Adapter*	1

*Not supplied with some versions.

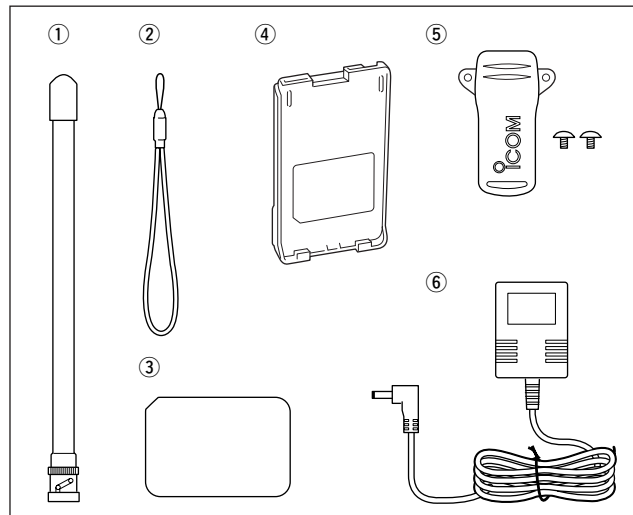

OPTION LIST

- **BP-226** BATTERY CASE
Battery case for 5×AA (LR6) size alkaline batteries.
- **BP-227** LI-ION BATTERY PACK
7.2 V/1700 mAh Lithium-Ion battery pack.
- **BC-119N** DESKTOP CHARGER + **AD-100** CHARGER ADAPTER
For rapid charging of battery packs. An AC adapter is supplied with the charger. Charging time: approx. 2–2.5 hrs.
- **BC-121N** MULTI-CHARGER + **AD-100** CHARGER ADAPTER
(6 pcs.)
For rapid charging of up to 6 battery packs (six AD-100's are required) simultaneously. An AC adapter may be supplied depending on version. Charging time: approx. 2–2.5 hrs.
- **CP-19R** CIGARETTE LIGHTER CABLE WITH NOISE FILTER
Used for operation and charging a battery pack connected to transceiver via a DC power source. (11.7 V–15.9 V DC)
- **MB-98** BELT CLIP
MB-98: Same as that supplied with the transceiver.
- **UT-108** DTMF DECODER UNIT
Provides pager and code squelch capabilities.
- **SP-13** EARPHONE
Provides clear receive audio in noisy environments.
- **FA-B2E** WHIP ANTENNA
Same as that supplied with transceiver.
- **HM-75A/HM-131L/HM-158L** SPEAKER-MICROPHONES
Combination speaker-microphones that provide convenient operation while hanging the transceiver from your belt. HM-75A has 4 function switches for remote control capabilities. HM-131L/HM-158L are equipped with an earphone jack and a revolving clip.
- **HM-128L/HM-153L/HM-166L** EARPHONE-MICROPHONE
You can clip the microphone with PTT switch to your lapel or breast pocket.
- **HS-85** HEADSET
Allows you hands-free operation. Includes VOX, PTT and “one-touch” PTT with time-out timer.
- **VS-1L** PTT/VOX UNIT+**HS-94** HEADSET
VS-1L PTT/VOX UNIT
Required when using the headset.
HS-94 EAR-PIECE TYPE HEADSET
Earhook headset with flexible boom microphone.
- **CS-V85** CLONING SOFTWARE+**OPC-478/U/UC** CLONING CABLE
Provide quick and easy programming of memory channel, memory name etc.
- **OPC-474** CLONING CABLE
For cloning between transceivers.
- **LC-167** CARRYING CASE
Helps protect the transceiver from scratches, etc..

TABLE OF CONTENTS

FOREWORD	i
IMPORTANT	i
EXPLICIT DEFINITIONS	i
PRECAUTIONS	ii–iii
SUPPLIED ACCESSORIES	iii
OPTION LIST	iv
TABLE OF CONTENTS	v–vi

QUICK REFERENCE GUIDE I–VI

■ Preparation	I
■ Your first contact	IV
■ Repeater operation	V
■ Programming memory channels	VI

1 ACCESSORIES..... 1–2

■ Accessory attachment	1
------------------------------	---

2 PANEL DESCRIPTION 3–8

■ Switches, controls, keys and connectors	3
■ Function display	7

3 BATTERY PACKS..... 9–16

■ Battery pack replacement	9
■ Cautions	11
■ Regular charging	13
■ Rapid charging	14
■ External DC power operation	16

4 BASIC OPERATION..... 17–21

■ Power ON	17
■ VFO mode selection	17
■ Setting a frequency	17
■ Setting audio/squelch level	19
■ Receive and transmit	19
■ Monitor function	19
■ Display type	20
■ Key lock function	20
■ Weather channel operation (USA version only)	21

5 REPEATER OPERATION 22–25

■ General	22
■ Reversed duplex mode	22
■ Offset frequency	23
■ Subaudible tones	23
■ Repeater lockout	24
■ Auto repeater function (USA version only)	25

6 MEMORY/CALL OPERATION 26–31

■ General description	26
■ Selecting a memory channel	26
■ Selecting the call channel	26
■ Programming the memory/call channels	27
■ Channel name programming	28
■ Memory transfers	28

■ Memory bank selection	30	11 SET MODES	47–56
■ Memory bank setting	30	■ SET MODE	47
■ Transferring bank contents.....	31	■ INITIAL SET MODE	51
7 DTMF MEMORY	32–34	12 SET MODE INSPECTION	57–58
■ Programming a DTMF code sequence	32	13 CLONING	59–60
■ Transmitting a DTMF code sequence	33	■ Transceiver-to-transceiver cloning	59
■ DTMF transmission rate	34	■ Cloning using a PC	60
8 SCAN OPERATION	35–38	14 RESETTING FUNCTIONS	61
■ Scan types	35	■ Partial reset	61
■ Programmed scan.....	35	■ CPU reset.....	61
■ Memory scan.....	36	15 TROUBLESHOOTING	62
■ Skip channels.....	37	16 OPTION	63
■ Scan resume condition.....	37	■ Optional UT-108 installation	63
■ Priority watch.....	38	17 SPECIFICATIONS	64
9 SUBAUDIBLE TONES	39–42	■ General	64
■ Tone squelch	39	■ Transmitter	64
■ Pocket beep operation	41	■ Receiver	64
■ Tone scan.....	42		
10 PAGER/CODE SQUELCH (Requires Optional UT-108)	43–46		
■ Pager function	43		
■ Code programming	43		
■ Pager operation.....	45		
■ Code squelch	46		

QUICK REFERENCE GUIDE

■ Preparation

◇ Antenna

Attach the antenna to the transceiver as illustrated at right.

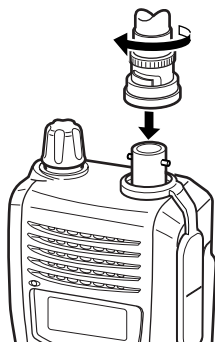

◇ Belt clip

Conveniently attaches to your belt. Attach the belt clip with the supplied screws using a phillips screwdriver.

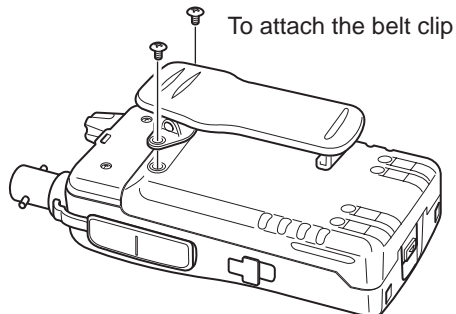

◇ Battery pack replacement

Before replacing the battery pack, push and hold [PWR] for 1 sec. to turn the power OFF.

• To attach the battery pack

Slide the battery pack on the back of the transceiver in the direction of the arrow (1), then lock it with the battery release button.

• Slide the battery pack until the battery release button makes a 'click' sound.

• To release the battery pack

Push the battery release button in the direction of the arrow (2) as shown below. The battery pack is then released.

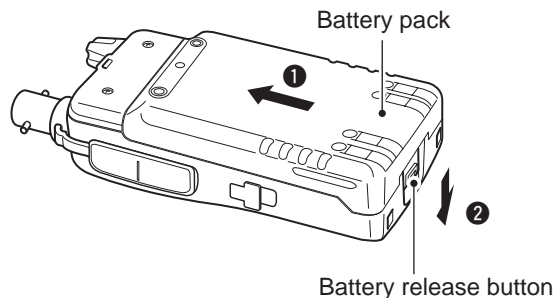

◇ **Battery case— optional for some versions**

When using a BP-226 BATTERY CASE attached to the transceiver, install 5 AA (LR6) size alkaline batteries as illustrated at right.

- ① Hook your finger under the latch, and open the cover in the direction of the arrow (❶). (Fig.1)
- ② Then, install 5 × AA (LR6) size alkaline batteries. (Fig.2)
 - Install the alkaline batteries only.
 - Be sure to observe the correct polarity.
 - Do not pin the ribbon under the batteries.
- ③ Close the cover with fitting in the direction of the arrow (❷) first, then firm the latch in place (❸). (Fig.1)
 - Be sure to the gasket and the ribbon are set correctly, and do not protrude out of the battery case. (Fig.3)

⚠ **CAUTION!**

- When installing batteries, make sure they are all the same brand, type and capacity. Also, do not mix new and old batteries together.
- Keep battery contacts clean. It's a good idea to clean battery terminals once a week.

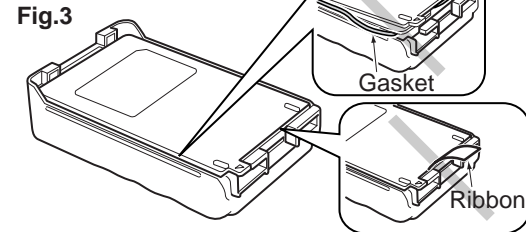
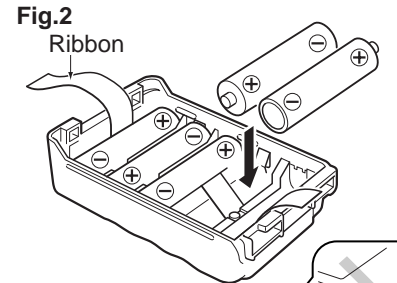
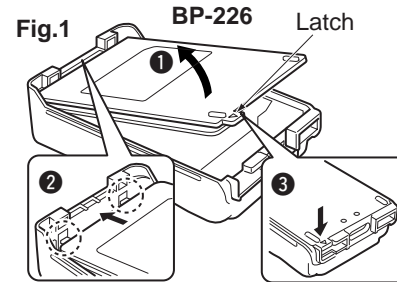

QUICK REFERENCE GUIDE

◆ Regular charging

When using a BP-227 BATTERY PACK attached to the transceiver, prior to using the transceiver for the first time, the battery pack must be fully charged for optimum life and operation.

◆ Charging note

- Be sure to turn the transceiver power OFF. Otherwise the battery pack will not be charged completely or takes longer charging time periods.
- External DC power operation becomes possible when using an optional CP-19R. The attached battery pack is also charged simultaneously, except during transmit. (see p. 16 for more details)

Even through there is no indication during regular charging, the transceiver automatically stops charging the battery pack when the battery pack is fully charged (BP-227's voltage becomes approx. 7.2 V) or the continuous charging time is over 15 hours.

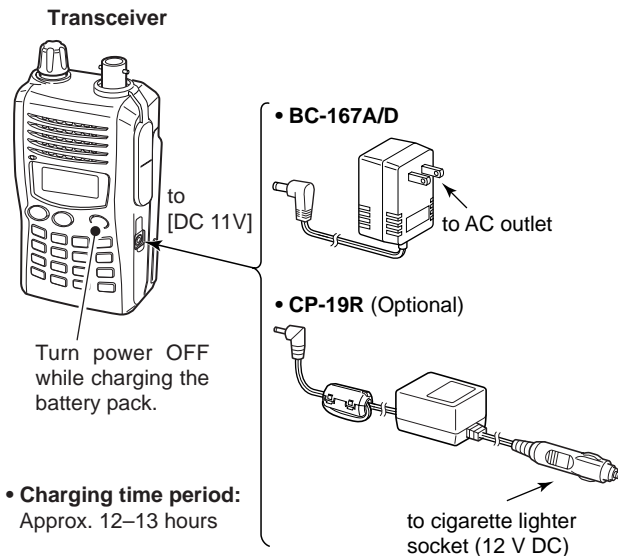

■ Your first contact

Now that you have your IC-V85 ready, you are excited to get on the air. We would like to walk you through a few basic operational steps to make your first “On The Air” use an enjoyable experience.

◇ About default setting

The [VOL] control function can be exchanged with [▲]/[▼] keys function in INITIAL SET MODE. However, in this QUICK REFERENCE, the factory default setting ([VOL] controls audio output level) is used to simplify instructions.

◇ Basic operation

1. Turning ON the transceiver

Although you have purchased a brand new transceiver, some settings may be changed from the factory defaults because of the Quality Control process. Resetting the CPU is necessary to start from factory default.

- ➔ While pushing [MONI] and [CLR], push and hold [PWR] for 1 sec. to reset the CPU and turn power ON.

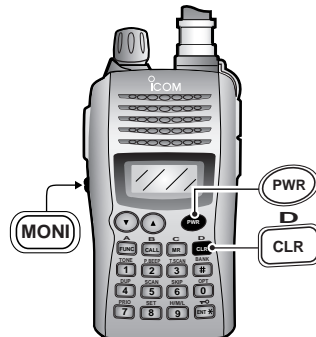

2. Adjusting audio output level

- ➔ Rotate [VOL] to set the desired audio level.



3. Adjusting the squelch level

- ➔ While pushing and holding [MONI], push [▲] or [▼] to set the squelch level.

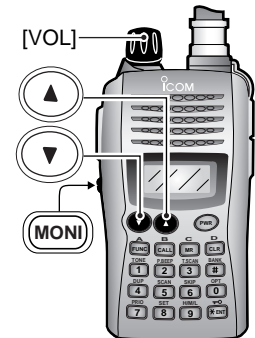
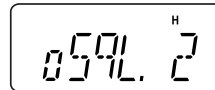

4. Tune the desired frequency

The up/down keys, [▲]/[▼], will allow you to tune to the frequency that you want to operate on. Page 18 will instruct you on how to adjust the tuning step size.

- ➔ Push [▲] or [▼] to adjust the frequency.

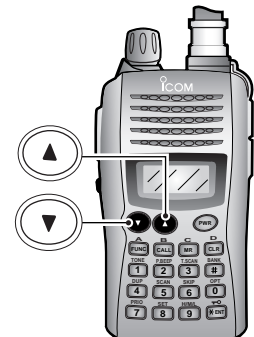

QUICK REFERENCE GUIDE

Direct frequency input from the keypad is also available.

➔ To enter the desired frequency, enter 6 digits starting from the 100 MHz digit.

- Entering three* to five digits then pushing **[* ENT]** will also set the frequency. (*Some versions only requires two digits.)
- When a digit is mistakenly input, push **[CLR]** to abort input.



• Example 1— when entering 145.525 MHz

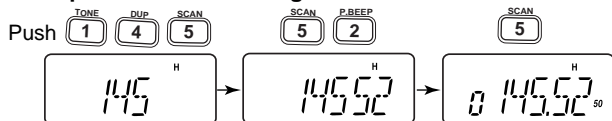

• Example 2— when entering 144.800 MHz



5. Transmit and receive

➔ Push and hold **[PTT]** to transmit, then speak into the microphone; release to receive.

■ Repeater operation

1. Setting duplex

- ➔ Push **[FUNC]**, then **[DUP](4)** several times to select minus duplex or plus duplex.
- The USA version has an auto repeater function, therefore, setting duplex is not required.

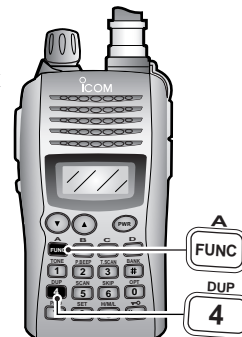
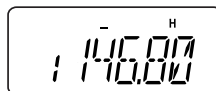

2. Repeater tone

- ➔ Push **[FUNC]**, then **[TONE](1)** several times until "J" appears, if required.

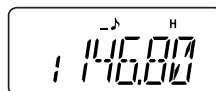

■ Programming memory channels

The IC-V85 has a total of 107 memory channels (including 6 scan edges and 1 call channel) for storing often used operating frequency, repeater settings, etc.

1. Setting frequency

In VFO mode, set the desired operating frequency with other desired settings, such as repeater and subaudible tone.

2. Selecting a memory channel

➔ Push **[FUNC]** and **[MR]** then push **[▲]** or **[▼]** several times to select the desired memory channel.

- “**MR**” indicator and memory channel number blink.

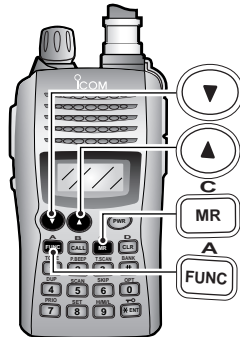
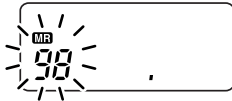

3. Writing a memory channel

➔ Push **[FUNC]**, then push and hold **[MR]** for 1 sec. to program.

- 3 beeps sound.

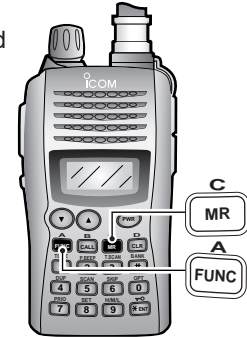
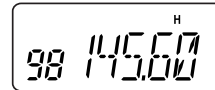

- Continue to push and hold **[MR]** for 1 sec. after 3 beeps are emitted, to increment the displayed memory channel number.

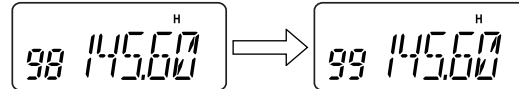

■ Accessory attachment

◇ Antenna

Attach the antenna to the transceiver as illustrated below.

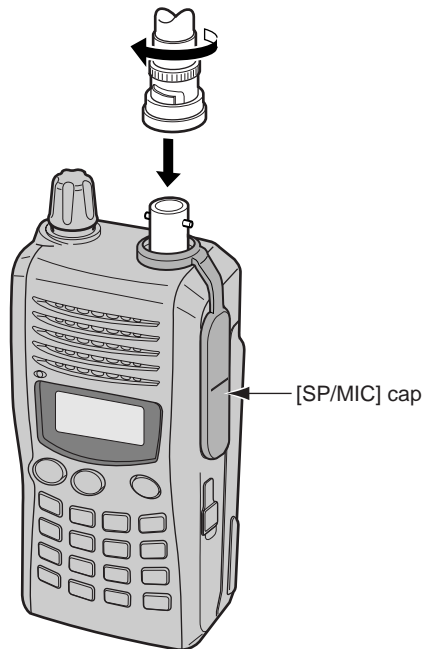

Keep the [SP/MIC] cap (SP/MIC jack cover) attached when jacks are not in use to keep the contacts clean.

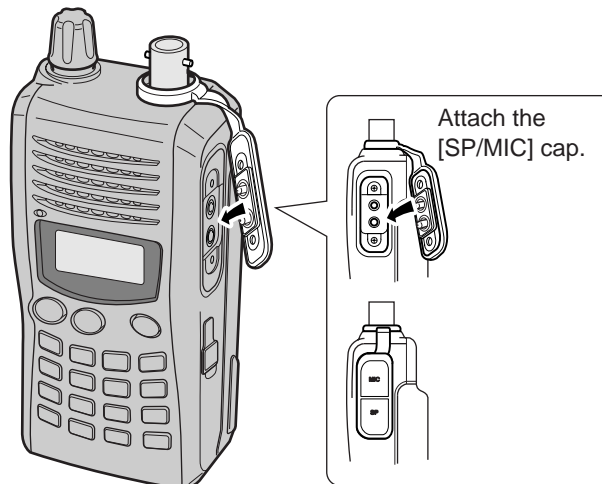

◆ Belt clip

Conveniently attaches to your belt.
Attach the belt clip with the supplied screws using a phillips screwdriver.

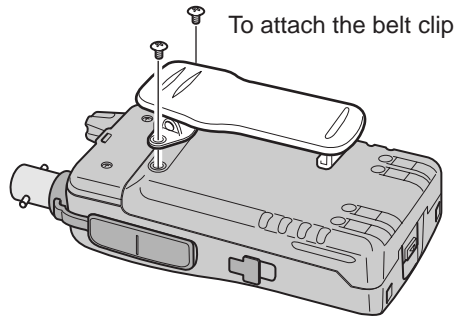

◆ Hand strap

Slide the hand strap through the loop on the top of the rear panel as illustrated below. Facilitates carrying.

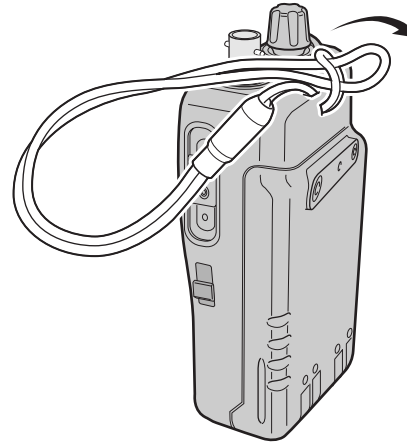

■ Switches, controls, keys and connectors



- ① **CONTROL DIAL [VOL]** (p. 19)
Rotate to adjust the volume level.
▨ The assigned function for [VOL] and [▲]/[▼] can be exchanged in INITIAL SET MODE (pgs. 18, 53).
- ② **PTT SWITCH [PTT]**
Push and hold to transmit; release to receive.
- ③ **SQUELCH/MONITOR SWITCH [MONI]** (p. 19)
 - ➔ Push and hold to open the squelch temporarily and monitor the operating frequency.
 - ➔ While pushing and holding this key, push [▲] or [▼] to adjust the squelch level.
▨ The assigned function for [VOL] and [▲]/[▼] can be exchanged in INITIAL SET MODE (pgs. 18, 53).
- ④ **UP/DOWN KEYS [▲]/[▼]** (p.18)
Selects the operating frequency, set mode items, etc.
▨ The assigned function for [VOL] and [▲]/[▼] can be exchanged in INITIAL SET MODE (pgs. 18, 53).
- ⑤ **KEYPAD** (pgs. 5, 6)
Used to enter operating frequency, the DTMF codes, etc.
- ⑥ **EXTERNAL DC JACK [DC 11V]**
 - ➔ Connect an external DC power supply through the optional CP-19R for external DC operation. (p. 16)
 - ➔ Connect the supplied (or optional) wall charger, BC-167A/D, to charge the attached battery pack. (p. 13)
- ⑦ **POWER KEY [PWR]** (p. 17)
Push and hold for 1 sec. to turn the power ON and OFF.
- ⑧ **FUNCTION DISPLAY** (pgs. 7, 8)
- ⑨ **EXTERNAL SPEAKER/MICROPHONE JACKS [SP/MIC]**
Connect an optional speaker-microphone or headset, if desired. The internal microphone and speaker will not function when a connector is inserted.
See page iv for a list of available options.
- ⑩ **ANTENNA CONNECTOR** (p. 1)
Connects the supplied antenna.

2 PANEL DESCRIPTION

◇ Keypad

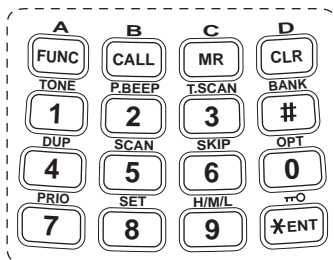

[FUNC]

Access to secondary function.



[CALL]

Selects the call channel. (p. 26)



[MR]

- ➔ Selects a memory mode. (p. 26)
- ➔ After pushing [FUNC], enter into memory programming/editing mode. (pgs. 27–29)
- ➔ After pushing [FUNC], programs/transfers VFO/memory or call channel contents into memory channel/VFO when pushed and held for 1 sec. (pgs. 27–29)



[CLR]

Selects VFO mode, aborts direct frequency input, or cancels scanning, etc. (pgs. 17, 35)



[1•TONE]

- ➔ Input digit “1” during frequency input, memory channel selection, etc. (pgs. 17, 26)
- ➔ After pushing [FUNC], selects the subaudible tone function. (pgs. 22, 39)



[2•P.BEEP]

- ➔ Input digit “2” during frequency input, memory channel selection, etc. (pgs. 17, 26)
- ➔ After pushing [FUNC], turns the pocket beep function ON and OFF. (p. 41)



[3•T.SCAN]

- ➔ Input digit “3” during frequency input, memory channel selection, etc. (pgs. 17, 26)
- ➔ After pushing [FUNC], starts tone scanning. (pgs. 24, 42)



[4•DUP]

- ➔ Input digit “4” during frequency input, memory channel selection, etc. (pgs. 17, 26)
- ➔ After pushing [FUNC], selects duplex function (–duplex, +duplex, simplex). (p. 22)



[5•SCAN]

- ➔ Input digit “5” during frequency input, memory channel selection, etc. (pgs. 17, 26)
- ➔ After pushing [FUNC], starts scanning. (p. 35)



[6•SKIP]

- Input digit “6” during frequency input, memory channel selection, etc. (pgs. 17, 26)
- After pushing **[FUNC]**, sets and cancels skip setting for memory scan during memory mode. (p. 37)



[7•PRIO]

- Input digit “7” during frequency input, memory channel selection, etc. (pgs. 17, 26)
- After pushing **[FUNC]**, starts priority watch. (p. 38)



[8•SET]

- Input digit “8” during frequency input, memory channel selection, etc. (pgs. 17, 26)
- After pushing **[FUNC]**, enters into SET MODE. (p. 47)



[9•H/M/L]

- Input digit “9” during frequency input, memory channel selection, etc. (pgs. 17, 26)
 - After pushing **[FUNC]**, switches transmit power between high, middle and low output power. (p. 19)
-  When the transceiver becomes hot during high or middle output power operation, the built-in protection circuit activates to reduce the transmit output power to 3 W (approx.).



[0•OPT]

- Input digit “0” during frequency input, memory channel selection, etc. (pgs. 17, 26)
- After pushing **[FUNC]**, selects an optional function mode, such as pager or code squelch operation. (pgs. 45, 46)



[#•BANK]

- After pushing **[FUNC]**, enters a memory bank selection. (p. 30)



[* ENT•T-O]

- Sets the frequency even if the full 6 digits of frequency have not been entered. (p. 17)
- After pushing **[FUNC]**, switches key lock function ON and OFF when pushed and held for 1 sec. Lock all keys, except **[PWR]**, **[PTT]**, **[MONI]** and audio level adjustment. (p. 20)

■ Function display

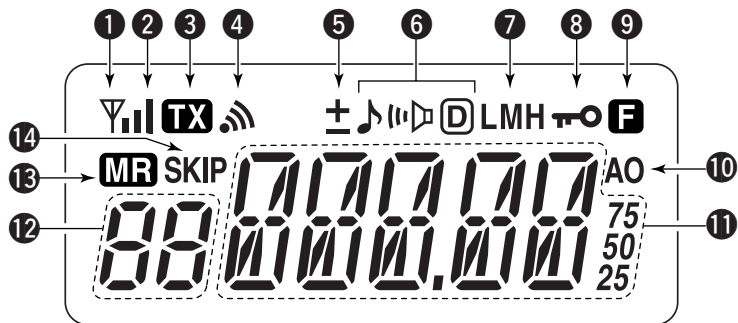

❶ BUSY INDICATOR

- Appears when a signal is being received or the squelch is open.
- Blinks while the monitor function is activated. (p. 19)

❷ SIGNAL INDICATOR

- Shows receiving signal strength as below.



Weak ⇐ RX Signal level ⇒ Strong

- Shows the output power level while transmitting.



❸ TRANSMIT INDICATOR (p. 19)

Appears during transmit.

❹ PAGER CALL INDICATOR (p. 46)

Blinks when a pager call is received. (This indicator appears only when an optional UT-108 DTMF DECODER UNIT is installed.)

❺ DUPLEX INDICATOR (p. 23)

“+” appears when plus duplex, “-” appears when minus duplex is selected.

6 TONE INDICATOR

- ➔ “J” appears while the subaudible tone encoder is in use. (p. 23)
- ➔ “D” appears while the tone (CTCSS) squelch function is in use. (p. 39)
- ➔ “@” appears while the tone (DTCS) squelch function is in use. (p. 39)
- ➔ “H” appears with the “D” or “@” indicator while the pocket beep function (CTCSS or DTCS) is in use. (p. 41)

7 OUTPUT POWER INDICATOR (p. 19)

- ➔ “L” appears when the low output power is selected.
- ➔ “M” appears when the middle output power is selected.
- ➔ “H” appears when high output power is selected.

8 KEY LOCK INDICATOR (p. 20)

Appears when the key lock function is ON.

9 FUNCTION INDICATOR

Appears while a secondary function is being accessed.

10 AUTO POWER OFF INDICATOR (p. 52)

Appears while the auto power OFF function is activated.

11 FREQUENCY READOUT

Shows operating frequency, channel number or channel names, depending on display type (p. 20).

12 MEMORY CHANNEL INDICATOR (p. 26)

- ➔ Shows the selected memory channel number.
- ➔ “C” appears when the call channel is selected.

13 MEMORY MODE INDICATOR (p. 26)

Appears while in memory mode or channel number indication mode.

14 SKIP CHANNEL INDICATOR (p. 37)

Appears when the selected memory channel is specified as a skip channel.

■ Battery pack replacement

- ① Before replacing the battery pack, push and hold **[PWR]** for 1 sec. to turn the power OFF.



- ② Push the battery release button in the direction of the arrow as shown below. The battery pack is then released.

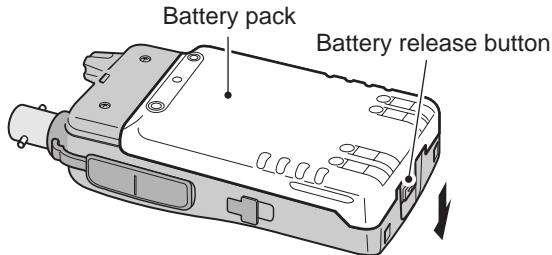

◇ Battery packs

Battery pack	Voltage	Capacity	Battery life*1
BP-226	Battery case for AA (LR6)×5 alkaline		—*2
BP-227	7.2 V	1700 mAh	7 hrs.

*1 Operating periods are calculated under the following conditions;
Tx : Rx : standby = 1 : 1 : 8, power save function: auto setting is activated

*2 Operating period depends on the alkaline cells used.

◇ Battery case— optional for some versions

When using a BP-226 BATTERY CASE attached to the transceiver, install 5 AA (LR6) size alkaline batteries as illustrated at right.

- ① Hook your finger under the latch, and open the cover in the direction of the arrow (❶). (Fig.1)
- ② Then, install 5 × AA (LR6) size alkaline batteries. (Fig.2)
 - Install the alkaline batteries only.
 - Be sure to observe the correct polarity.
 - Do not pin the ribbon under the batteries.
- ③ Close the cover with fitting in the direction of the arrow (❷) first, then firm the latch in place (❸). (Fig.1)
 - Be sure to the gasket and the ribbon are set correctly, and do not protrude out of the battery case. (Fig.3)

⚠ CAUTION!

- When installing batteries, make sure they are all the same brand, type and capacity. Also, do not mix new and old batteries together.
- Keep battery contacts clean. It's a good idea to clean battery terminals once a week.

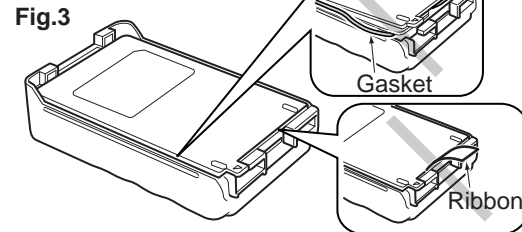
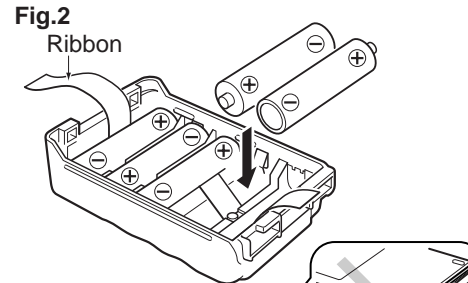
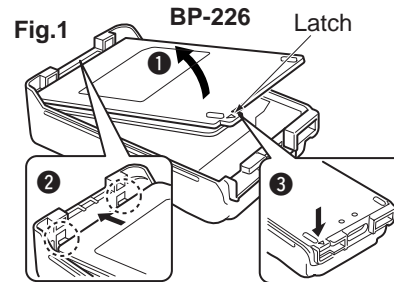

■ Cautions

Misuse of Lithium-Ion batteries may result in the following hazards: smoke, fire, or the battery may rupture. Misuse can also cause damage to the battery or degradation of battery performance.

- ⚠ **DANGER!** Use and charge only specified Icom battery packs with Icom radios. Only Icom battery packs are tested and approved for use with Icom radios. Using third-party or counterfeit battery packs may cause smoke, fire, or cause the battery to burst.

◆ Battery caution

- ⚠ **DANGER! DO NOT** hammer or otherwise impact the battery. Do not use the battery if it has been severely impacted or dropped, or if the battery has been subjected to heavy pressure. Battery damage may not be visible on the outside of the case. Even if the surface of the battery does not show cracks or any other damage, the cells inside the battery may rupture or catch fire.
 - ⚠ **DANGER! NEVER** use or leave battery pack in areas with temperatures above +60°C (+140°F). High temperature build up in the battery, such as could occur near fires or stoves, inside a sun heated car, or in direct sunlight may cause the battery to rupture or catch fire. Excessive temperatures may also degrade battery performance or shorten battery life.
- ⚠ **DANGER! DO NOT** expose the battery to rain, snow, seawater, or any other liquids. Do not charge or use a wet battery. If the battery gets wet, be sure to wipe it dry before using.
 - ⚠ **DANGER! NEVER** incinerate an used battery pack since internal battery gas may cause it to rupture, or may cause an explosion.
 - ⚠ **DANGER! NEVER** solder the battery terminals, or **NEVER** modify the battery pack. This may cause heat generation, and the battery may burst, emit smoke or catch fire.
 - ⚠ **DANGER!** Use the battery only with the transceiver for which it is specified. Never use a battery with any other equipment, or for any purpose that is not specified in this instruction manual.
 - ⚠ **DANGER!** If fluid from inside the battery gets in your eyes, blindness can result. Rinse your eyes with clean water, without rubbing them, and see a doctor immediately.
 - **WARNING!** Immediately stop using the battery if it emits an abnormal odor, heats up, or is discolored or deformed. If any of these conditions occur, contact your Icom dealer or distributor.
 - **WARNING!** Immediately wash, using clean water, any part of the body that comes into contact with fluid from inside the battery.

- **WARNING! NEVER** put the battery in a microwave oven, high-pressure container, or in an induction heating cooker. This could cause a fire, overheating, or cause the battery to rupture.
- **CAUTION!** Always use the battery within the specified temperature range for the transceiver (−10°C to +60°C; +14°F to +140°F) and the battery itself (−10°C to +60°C; +14°F to +140°F). Using the battery out of its specified temperature range will reduce the battery's performance and battery life.
- **CAUTION!** Shorter battery life could occur if the battery is left fully charged, completely discharged, or in an excessive temperature environment (above +45°C; +113°F) for an extended period of time. If the battery must be left unused for a long time, it must be detached from the radio after discharging. You may use the battery until the battery becomes about half-capacity, then keep it safely in a cool dry place with the temperature between −20°C to +35°C (−4°F to +95°F).

◇ Charging caution

- **⚠ DANGER! NEVER** charge the battery pack in areas with extremely high temperatures, such as near fires or stoves, inside a sun heated car, or in direct sunlight. In such environments, the safety/protection circuit in the battery will activate, causing the battery to stop charging.
- **WARNING! DO NOT** charge or leave the battery in the battery charger beyond the specified time for charging. If the battery is not completely charged by the specified time, stop charging and remove the battery from the battery charger. Continuing to charge the battery beyond the specified time limit may cause a fire, overheating, or the battery may rupture.
- **WARNING! NEVER** insert the transceiver (battery attached to the transceiver) into the charger if it is wet or soiled. This could corrode the battery charger terminals or damage the charger. The charger is not waterproof.
- **CAUTION! DO NOT** charge the battery outside of the specified temperature range: 10°C to +40°C (+50°F to +104°F). Icom recommends charging the battery at +20°C (+68°F). The battery may heat up or rupture if charged out of the specified temperature range. Additionally, battery performance or battery life may be reduced.

3 BATTERY PACKS

■ Regular charging

When using a BP-227 BATTERY PACK attached to the transceiver, prior to using the transceiver for the first time, the battery pack must be fully charged for optimum life and operation.

◇ Charging note

- Be sure to turn the transceiver power OFF. Otherwise the battery pack will not be charged completely or takes longer charging time periods.
- External DC power operation becomes possible when using an optional CP-19R. The attached battery pack is also charged simultaneously, except during transmit. (see p. 16 for more details)

Even through there is no indication during regular charging, the transceiver automatically stops charging the battery pack when the battery pack is fully charged (BP-227's voltage becomes approx. 7.2 V) or the continuous charging time is over 15 hours.

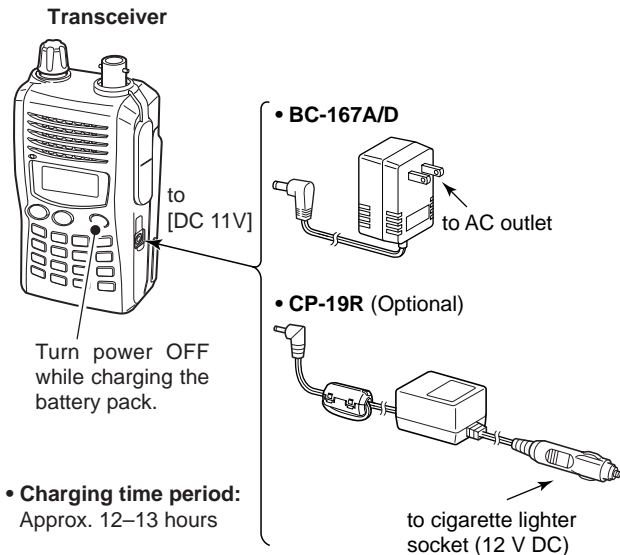

■ Rapid charging

◇ AD-100 installation

Install the AD-100 desktop charger adapter into the holder space of the BC-119N/121N.

Connect the plugs of the BC-119N/121N to the AD-100 desktop charger adapter with the connector, then install the adapter into the charger with the supplied screws.

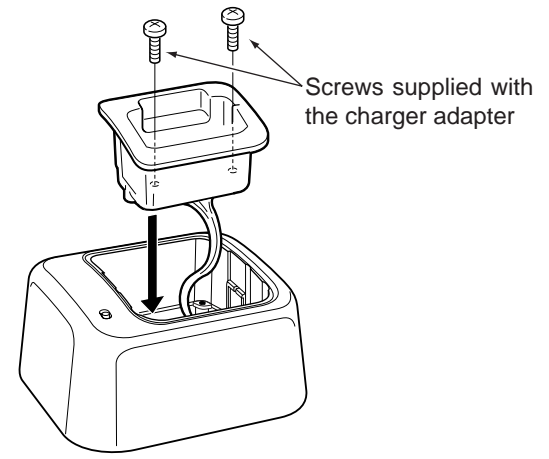
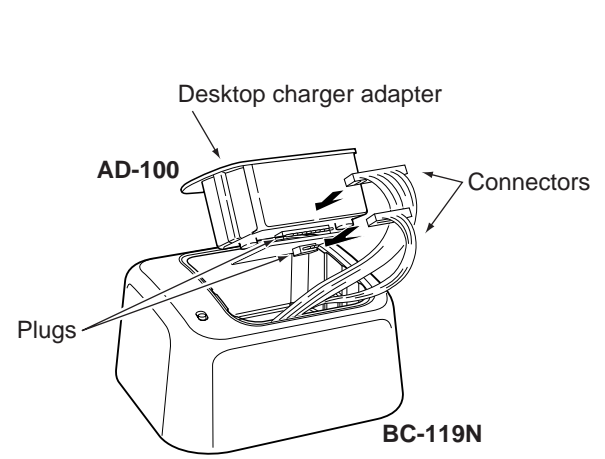

3 BATTERY PACKS

◇ Rapid charging with the BC-119N+AD-100

The optional BC-119N provides rapid charging of battery packs. The following items are additionally required.

- AD-100 (Charger Adapter).
- An AC adapter (may be supplied with the BC-119N depending on version) or the DC power cable (OPC-515L/CP-17L).

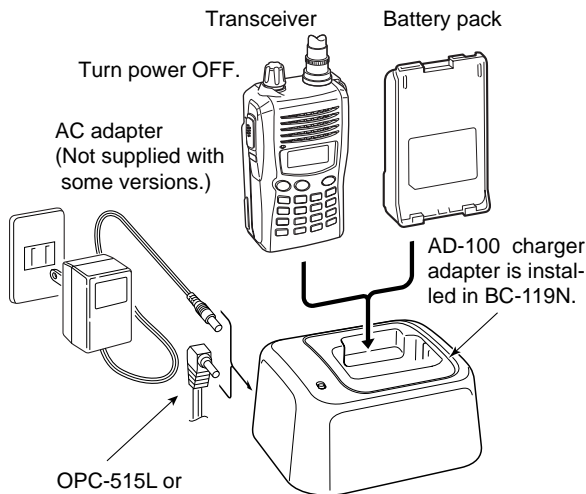

Optional OPC-515L (for 13.8 V power source) or CP-17L (for 12 V cigarette lighter socket) can be used instead of the AC adapter.

◇ Rapid charging with the BC-121N+AD-100

The optional BC-121N allows up to 6 battery packs to be charged simultaneously. The following items are additionally required.

- Six AD-100 (Charger Adapter).
- An AC adapter (BC-157; may be supplied with the BC-121N depending on version) or the DC power cable (OPC-656).

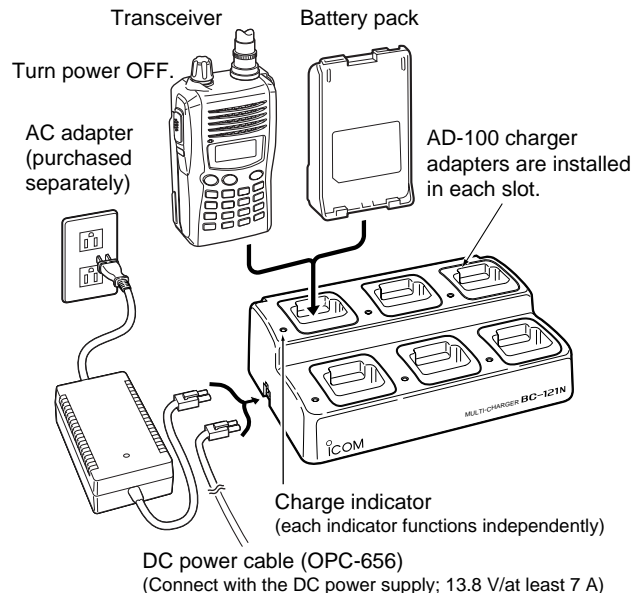

■ External DC power operation

An optional cigarette lighter cable (CP-19R; for 12 V cigarette lighter socket) can be used for external power operation.

◇ Operating note

- **BE SURE** to use optional **CP-19R** when connecting a regulated 12 V DC power supply into the [DC 11V] jack of the transceiver.
- The voltage of the external power supply must be within **11.7–15.9 V DC** when using CP-19R.
- **NEVER CONNECT OVER 16 V DC** through CP19R.
Use an external DC-DC converter to connect the transceiver through CP-19R to a 24 V DC power source.
- Disconnect the power cables from the transceiver when not using it. Otherwise, the vehicle battery will become exhausted.
- The power save function is deactivated automatically during external DC power operation.

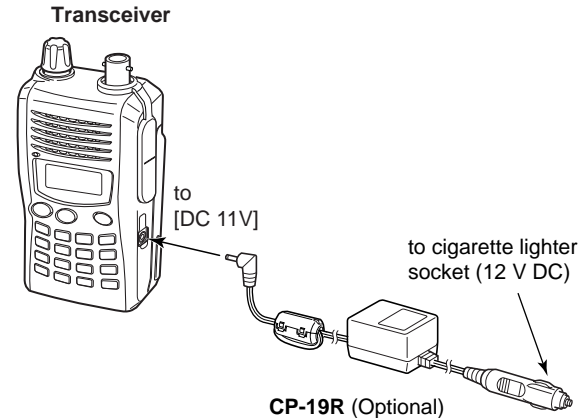

■ Power ON

- ➔ Push and hold [PWR] for 1 sec. to turn power ON.



■ VFO mode selection

The transceiver has 2 basic operating modes: VFO mode and memory mode.

- ➔ Push [CLR] to select VFO mode.



■ Setting a frequency

◇ Via the keypad

- ① Push [CLR] to select VFO mode, if necessary.
- ② To enter the desired frequency, enter 6 digits starting from the 100 MHz digit.
 - Entering three* to five digits then pushing [* ENT] will also set the frequency. (*Some versions only requires two digits.)
 - When changing 100 kHz and below, push [#] then enter the desired digits.
 - When a digit is mistakenly input, push [CLR] to abort input.

• Example 1— when entering 145.525 MHz

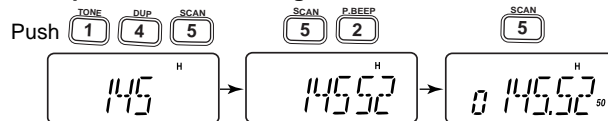

• Example 2— when entering 144.800 MHz



• Example 3— when entering 145.000 MHz from 145.525 MHz

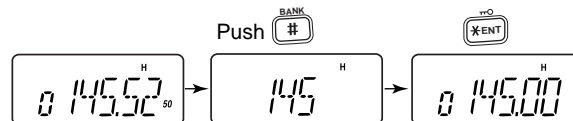

◇ By other methods

Via the [▲]/[▼] keys

- ➔ Push [▲] or [▼] several times to set the desired frequency.
 - Each push increases/decreases the frequency by the selected tuning step. See next set of instructions for setting tuning step size.

◇ Tuning step selection

The IC-V85 has 8 tuning steps—5, 10, 12.5, 15, 20, 25, 30 and 50 kHz. The tuning step is selectable in SET MODE.

- ① Push [FUNC] then [SET](8) to enter SET MODE.
- ② Push [▲] or [▼] several times to select the tuning step item.

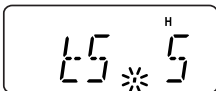

- ③ Rotate [VOL] to select the desired tuning step.
- ④ Push [* ENT] (or [CLR]) to exit SET MODE.

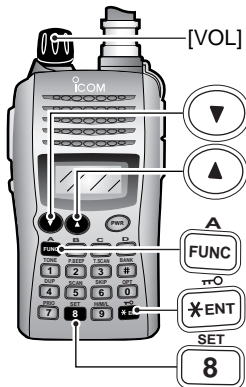

✓ For your information— [VOL] function assignment

The [VOL] control can be used as a tuning dial for frequency tuning instead of [▲]/[▼] keys. However, when [VOL] functions as tuning dial, [▲]/[▼] keys function as volume control.

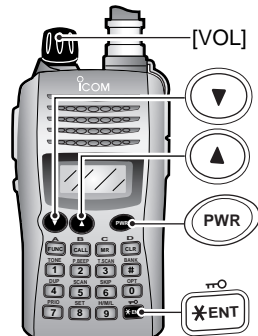

- ① While pushing and holding [▲] and [▼], turn power ON to enter INITIAL SET MODE.
- ② Push [▲] or [▼] several times to select the dial assignment item, "tOP."
- ③ Rotate [VOL] to select the condition.

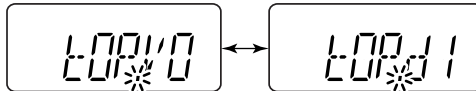

[VOL] is assigned as AF volume control.

[VOL] is assigned as tuning dial.

- ④ To exit INITIAL SET MODE, push [* ENT] (or [CLR]).

■ Setting audio/squelch level

◇ To set the audio level

Rotate **[VOL]** to set the desired audio level while receiving a signal.

- When no signal is received, push and hold **[MONI]** while setting the audio level.
- When **[VOL]** is assigned as tuning dial, push **[▲]/[▼]** to adjust the audio output level. (pgs. 18, 53)



◇ To set the squelch level

While pushing **[MONI]**, push **[▲]/[▼]** to set the squelch level.

- The squelch level "10" is tight squelch, "1" is loose squelch and "0" is open squelch.
- When **[VOL]** is assigned as tuning dial, rotate **[VOL]** while pressing **[MONI]**. (pgs. 18, 53)

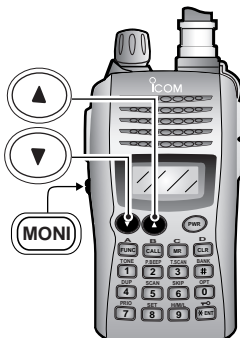

■ Receive and transmit

- ① Push and hold **[PWR]** for 1 sec. to turn the power ON.
- ② Adjust audio volume to the desired level.
- ③ Set the frequency.
 - When a signal is received:
 - Squelch opens and audio is emitted from the speaker.
 - Signal indicator shows the relative signal strength level.
- ④ Push **[FUNC]**, then **[H/M/L](9)** to select output power between high, middle and low.
 - "H" appears when high power is selected.
 - "M" appears when middle power is selected.
 - "L" appears when low power is selected.
- ⑤ Push and hold **[PTT]** to transmit, then speak into the microphone.
 - **[TX]** appears.
 - **Do not** hold the microphone too close to your mouth or speak too loudly. This may distort the signal.
- ⑥ Release **[PTT]** to receive.

■ Monitor function

This function is used to listen to weak signals without disturbing the squelch setting or to open the squelch manually even when mute functions such as the tone squelch are in use.

- Push and hold **[MONI]** to monitor the operating frequency.

▨ The **[MONI]** key can be set to 'sticky' operation in INITIAL SET MODE. See page 55 for details.

■ Display type

USING INITIAL SET MODE

The transceiver has 3 display types to suit your operating style during memory mode operation. The display type is selected in INITIAL SET MODE (p. 53).

“Frequency Indication” type

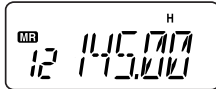

Displays operating frequency.

“Channel Number Indication” type

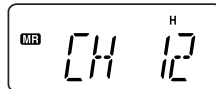

Displays memory channel number. In this type only pre-programmed memory channel numbers are displayed.

VFO mode cannot be selected.

- When the channel indication type is selected, only the following functions can be performed.
 - Scan function (p. 35)
 - Output power setting (p. 19)
 - DTMF memory function (p. 32)
 - Key lock function (see next set of instructions)
 - Scan pause timer setting, function key timer setting and LCD backlight setting in SET MODE (p. 49)

“Channel Name Indication” type

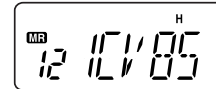

Displays memory channel name you have assigned. In this display pre-programmed memory channel names are displayed.

VFO mode is selectable.

- Programmed frequencies are indicated when you have not pre-programmed the channel names in the selected memory channel.
- Push and hold **[MONI]** to display the operating frequency.

■ Key lock function

The key lock function prevents accidental frequency changes and function activation.

Push **[FUNC]** then push and hold **[*ENT]** for 1 sec. to toggle the function ON and OFF.

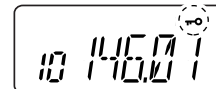

- “” appears while the lock function is activated.
- **[PWR]**, **[PTT]**, **[VOL]** and **[MONI]** can be operated regardless of this setting.

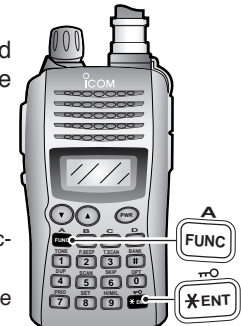

■ Weather channel operation (USA version only)

◆ Weather channel selection

- ① Push **[MR]** several times to select weather channel group.

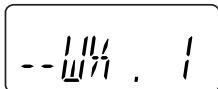

Weather channel group indication

- ② Push **[▲]** or **[▼]** several times to select the desired weather channel.
- ③ Push **[MR]** to select memory mode, or push **[CLR]** to select VFO mode.

◆ Weather alert function

USING SET MODE

An NOAA broadcast station transmits weather alert tone before important weather announcements. When the weather alert function is turned ON, the selected weather channel is monitored each 5 sec. for the announcement. When the alert signal is detected, the “ALt” and the WX channel are displayed alternately and sounds a beep tone until the transceiver controls are manipulated. The previously selected weather channel is checked periodically during standby or while scanning.

- ① Select the desired weather channel.
- ② Turn the weather alert function ON in SET MODE.
 - ➔ Push **[FUNC]** and **[SET](8)** to enter SET MODE.
 - ➔ Push **[▲]** or **[▼]** to select the weather alert item, then rotate **[VOL]** to set ON.
 - ➔ push **[* ENT]** (or **[CLR]**) to exit SET MODE.
- ③ Select the desired stand-by condition.
 - Select VFO, memory or call channel.
 - Scan or priority watch operation can also be selected.
- ④ When the alert is detected, a beep sounds and the following indication will be displayed.

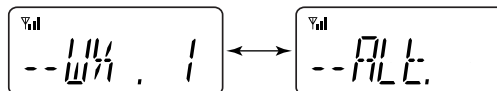

Shows above indications alternately.

• Weather alert function OFF

- ➔ Turn the weather alert function OFF in SET MODE.
 - Repeat above procedure described at step ②

NOTE: While receiving a signal (on a frequency other than the weather alert ON frequency), the receiving signal or audio will be interrupted momentarily every 5 sec. (approx.) in case the alert function is turned ON. This is caused by the WX alert function. To eliminate the interruptions, set the weather alert item OFF in SET MODE.

■ General

When using a repeater, the transmit frequency is shifted from the receive frequency by the offset frequency. It is convenient to program repeater information into memory channels.

- ① Set the receive frequency (repeater output frequency).
- ② Push **[FUNC]** and **[DUP]**(4) several times to select “-” or “+.”
 - “-” indicates the transmit frequency is shifted down; “+” indicates the transmit frequency is shifted up.
 - Blinking “-” or “+” indicates the reversed duplex mode is selected in SET MODE (p. 48).
- ③ Push **[FUNC]** and **[TONE]**(1) several times to activate the subaudible tone encoder, if required.
 - “♪” appears.
 - Select the desired subaudible tone frequency, if necessary. (p. 23)
- ④ Push and hold **[PTT]** to transmit.
 - The displayed frequency automatically changes to the transmit frequency (repeater input frequency).
 - If “OFF” appears, check the offset frequency (see next page for details) and direction.
- ⑤ Release **[PTT]** to receive.
- ⑥ Push and hold **[MONI]** to check whether the other station’s transmit signal can be directly received.

■ Reversed duplex mode

USING SET MODE

When the reversed duplex mode is selected, the receive frequency shifts. (Transmit frequency shifts in normal duplex mode.) Each receive and transmit frequency is shown in the table below with the following conditions;

Input frequency	: 145.30 MHz
Direction	: - (negative)
Offset frequency	: 0.6 MHz

- ① Push **[FUNC]**, then push **[SET]**(8) to enter SET MODE.
- ② Push **[▲]** or **[▼]** several times until “REV” appears.

Reversed	OFF	ON
Rx freq.	145.30 MHz	144.70 MHz
Tx freq.	144.70 MHz	145.30 MHz

- ③ Rotate **[VOL]** to turn the reversed duplex mode ON or OFF.
- ④ Push **[* ENT]** (or **[CLR]**) to exit SET MODE.

5 REPEATER OPERATION

■ Offset frequency

USING SET MODE

When communicating through a repeater, the transmit frequency is shifted from the receive frequency by an amount determined by the offset frequency.

- ① Push **[FUNC]**, then push **[SET]**(8) to enter SET MODE.
- ② Push **[▲]** or **[▼]** several times until “±” and offset frequency appear.



- ③ Rotate **[VOL]** to select the desired offset frequency.
 - Selectable steps are the same as the pre-set tuning steps.
 - The unit of the displayed offset frequency is “MHz.”
- ④ Push **[* ENT]** (or **[CLR]**) to set the offset frequency and exit SET MODE.

■ Subaudible tones

USING SET MODE

Some repeaters require subaudible tones to be accessed. Subaudible tones are added to your normal signal and must be set in advance.

- ① Push **[FUNC]**, then push **[SET]**(8) to enter SET MODE.
- ② Push **[▲]** or **[▼]** several times until “rt” appears.



- ③ Rotate **[VOL]** to select the desired subaudible tone.
- ④ Push **[* ENT]** (or **[CLR]**) to set the selected tone and exit SET MODE.

• Available subaudible tone frequencies (unit: Hz)

67.0	85.4	107.2	136.5	165.5	186.2	210.7	254.1
69.3	88.5	110.9	141.3	167.9	189.9	218.1	
71.9	91.5	114.8	146.2	171.3	192.8	225.7	
74.4	94.8	118.8	151.4	173.8	196.6	229.1	
77.0	97.4	123.0	156.7	177.3	199.5	233.6	
79.7	100.0	127.3	159.8	179.9	203.5	241.8	
82.5	103.5	131.8	162.2	183.5	206.5	250.3	

◇ Tone information

Some repeaters require different tone system to be accessed.

DTMF TONES

While pushing [PTT], push the desired DTMF keys ([0]–[9], [A], [B], [C], [D], [#] and [*]) to transmit DTMF tones.

- [*] transmits tone “E,” [#] transmits tone “F.”
- The transceiver has 16 DTMF memory channels (p. 32).

1750 Hz TONE

While pushing [PTT], push [▲] or [▼] to transmit a 1750 Hz tone signal.

✓ Convenient

Tone scan function: When you don’t know the subaudible tone used for a repeater, the tone scan is convenient for detecting the tone frequency.

Push [FUNC], then push [T.SCAN](3) to start the tone scan.

- Push [CLR] to cancel the scan.
- When the required tone frequency is detected, the scan pauses.

■ Repeater lockout

USING INITIAL SET MODE

This function helps prevent interference to other stations by inhibiting your transmission when a signal is received. The transceiver has two inhibiting conditions, repeater and busy.

- ① While pushing and holding [▲] and [▼], turn the power ON to enter INITIAL SET MODE.
- ② Push [▲] or [▼] several times until “RLO” appears.
- ③ Rotate [VOL] to select the repeater lockout function to “RP,” “bU” or OFF.
 - “RP”: Transmit is inhibited when a signal with un-matched sub-audible tone is received.
 - “bU”: Transmit is inhibited when a signal is received.

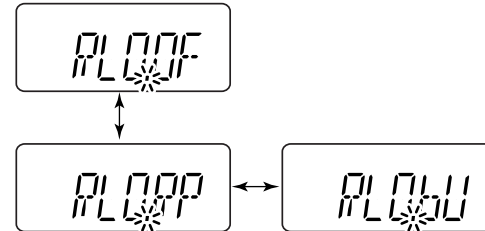

- ④ Push [* ENT] (or [CLR]) to exit INITIAL SET MODE.

5 REPEATER OPERATION

■ Auto repeater function (USA version only)

USING INITIAL SET MODE

The USA version automatically activates the repeater settings (duplex ON/OFF, duplex direction, tone encoder ON/OFF) when the operating frequency falls within or outside of the general repeater output frequency range. The offset and repeater tone frequencies are not changed by the auto repeater function. Reset these frequencies, if necessary.

- ① While pushing and holding [▲] and [▼], turn the power ON to enter INITIAL SET MODE.
- ② Push [▲] or [▼] several times until "RPt" appears.
- ③ Rotate [VOL] to select the desired condition.
 - "OF"— the auto repeater function is turned OFF;
 - "R1"— the auto repeater function activates duplex only;
 - "R2"— the auto repeater function activates duplex and tone.

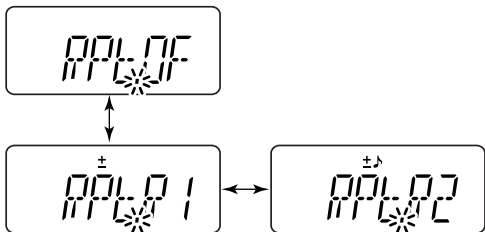

- ④ Push [* ENT] (or [CLR]) to exit INITIAL SET MODE.

• Frequency range and offset direction

Frequency range	Duplex direction
145.200–145.495 MHz 146.610–146.995 MHz	“–” appears
147.000–147.395 MHz	“+” appears

■ General description

The transceiver has 107 memory channels including 6 scan edge memory channels (3 pairs), and 1 call channel. Each of these channels can be individually programmed with operating frequency (pgs. 17, 18), duplex direction (p. 22) and offset (p. 23), subaudible tone encoder or tone squelch and its tone frequency (pgs. 23, 40) and skip information* (p. 37).

*except for scan edge memory channels.

In addition, a total of 10 memory banks, A to J, are available for usage by group, etc.

5

6

■ Selecting a memory channel

① Push **[MR]** to select memory mode.

- “**MR**” appears.



② Enter 2 digits to select the desired memory channel (or push the **[▲]**/**[▼]** keys).

- The memory channels 0–9 are preceded by a “0.”
- When **[VOL]** is assigned as tuning dial, rotate **[VOL]** to select the memory channel. (pgs. 18, 53)

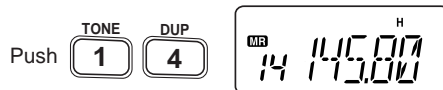

(Selection example: Memory channel 14)

■ Selecting the call channel

➔ Push **[CALL]** to select the call channel.

- “**C**” is displayed instead of the memory channel number.
- Push **[CLR]** or **[MR]** to select VFO or memory mode, respectively.

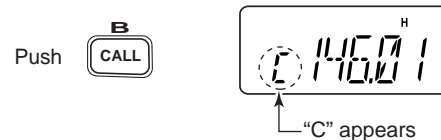

6 MEMORY/CALL OPERATION

■ Programming the memory/call channels

- ① Push **[CLR]** to select VFO mode, if necessary.
- ② Set the desired frequency.
- ③ Set other information, such as tone, duplex, as desired.
- ④ Push **[FUNC]**, then **[MR]** momentarily.
 - “**MR**” and memory channel number blink.

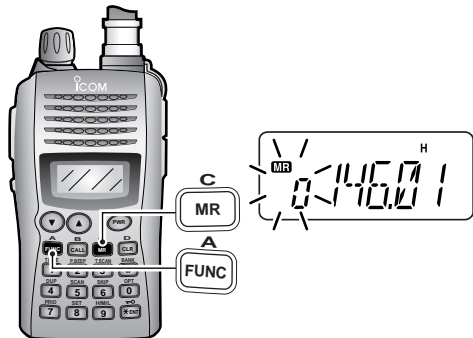

- ⑤ Push **[▲]** or **[▼]** to select the desired memory channel.
 - When programming the call channel, select “C.”
 - When **[VOL]** is assigned as tuning dial, rotate **[VOL]** to select the memory channel. (pgs. 18, 53)

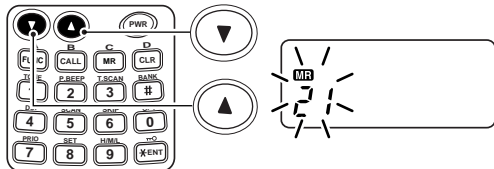

- ⑥ Push **[FUNC]**, then push and hold **[MR]** for 1 sec., when 3 beeps will sound to program the information into the selected memory channel and return to VFO.

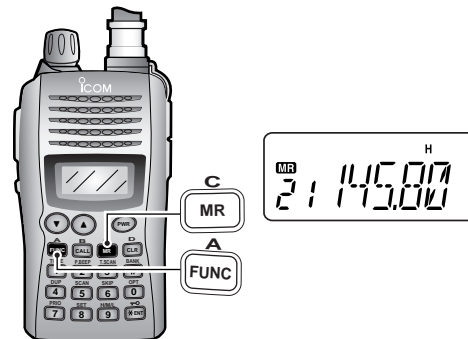

- After 3 beeps are emitted, continue to hold **[MR]** to increment the displayed memory channel number.

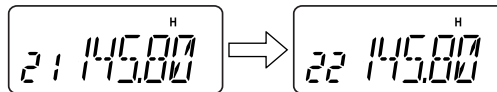

■ Channel name programming

- ① Select a “Channel Name Indication” type in INITIAL SET MODE (p. 53).
- ② Push **[MR]** to select memory mode, if necessary.
- ③ Push **[FUNC]**, then push **[SET]**(8) to enter to the channel name programming mode.
 - The character to be edited blinks.
- ④ Rotate **[VOL]** to select a character.



- ⑤ Push **[▲]** to move the cursor to right, **[▼]** to move the cursor to left.
 - Up to 5 characters can be used for channel name.
 - Usable characters are A–Z, 0–9, “space,” +, -, =, *, /, [,] and :.
- ⑥ Push **[*ENT]** (or **[CLR]**) to set the name and exit the channel name programming mode.

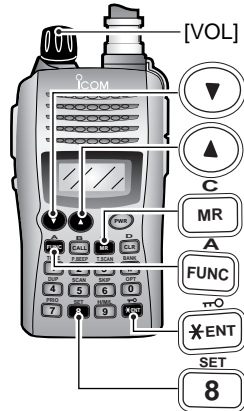
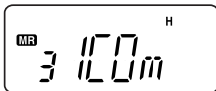

■ Memory transfers

This function transfers a memory channel’s contents to VFO (or another memory/call channel). This is useful when searching for signals around a memory channel frequency and for recalling the offset frequency, subaudible tone frequency etc.

◇ Memory/call ⇒ VFO

- ① Select the memory (call) channel to be transferred:
 - Push **[MR]** (or **[CALL]**) to select memory (call) mode.
 - Push **[▲]** or **[▼]** to select the memory channel.
 - When **[VOL]** is assigned as tuning dial, rotate **[VOL]** to select the memory channel. (pgs. 18, 53)
- ② Push **[FUNC]**, then push and hold **[MR]** for 1 sec. to transfer the selected memory contents to the VFO.
 - VFO mode is selected automatically.

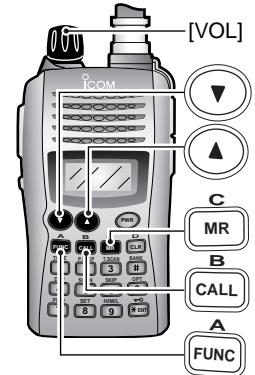

6 MEMORY/CALL OPERATION

◇ Memory/call ⇒ memory/call

- ① Select the memory (call) channel to be transferred:

➔ Push **[MR]** (or **[CALL]**) to select the memory (call channel) mode.

➔ Push **[▲]** or **[▼]** to select the memory channel.

- When **[VOL]** is assigned as tuning dial, rotate **[VOL]** to select the memory channel. (pgs. 18, 53)

- ② Push **[FUNC]**, then push **[MR]** momentarily.

- “-” and “MR” blink.

- ③ Push **[▲]** or **[▼]** to select the target memory.

- When **[VOL]** is assigned as tuning dial, rotate **[VOL]** to select the target channel. (pgs. 18, 53)

- ④ Push **[FUNC]**, then push and hold **[MR]** for 1 sec.

- Memory mode is selected and the contents are transferred to the target memory.

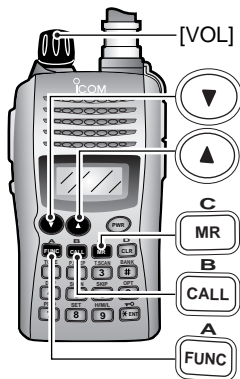

◇ Clearing a memory

- ① Push **[CLR]** to select VFO mode, if necessary.

- ② Push **[FUNC]**, then push **[MR]** to enter the memory transfer mode.

- “MR” and a memory channel number blink.

- ③ Push **[▲]** or **[▼]** to select the memory channel to be cleared.

- When **[VOL]** is assigned as tuning dial, rotate **[VOL]** to select the memory channel. (pgs. 18, 53)

- The call channel cannot be cleared.

- ④ Perform the following operation within 1 sec, otherwise the transceiver returns to the memory mode without clearing the memory.

- Push **[FUNC]**, then push **[MR]** momentarily.
- Push **[FUNC]**, then push and hold **[MR]** for 1 sec.
- The contents of the selected memory are cleared.

- ⑤ Push **[CLR]** to return to regular operation.

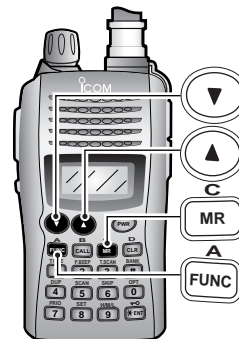

■ Memory bank selection

The IC-V85 has a total of 10 banks (A to J). Each memory channel, 0 to 99, may be assigned to one of the banks for easy memory management.

- ① Push **[MR]** to select memory mode.



- ② Push **[FUNC]** and **[BANK](#)** to enter memory bank selection.
 - Bank indicator blinks.

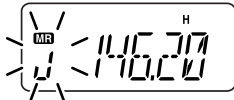

- ③ Rotate **[VOL]** to select the desired bank, A to J.
 - Banks that have no programmed contents are skipped.

- ④ Push **[* ENT]** (or **[CLR]**) to select the bank.
 - Indicator stops blinking.

- ⑤ Push **[▲]** or **[▼]** to select the channel in the bank.
 - No channel numbers are displayed for memory bank operation.

- ⑥ To return to regular memory condition, push **[FUNC]** and **[BANK](#)** to enter memory bank mode, then push **[* ENT]** (or **[CLR]**).

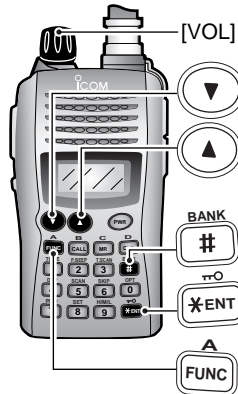

■ Memory bank setting

- ① Push **[MR]** to select memory mode, then select the desired memory channel via **[▲]** or **[▼]**.



- ② Push **[FUNC]** and **[SET](8)** to enter SET MODE.
- ③ Push **[▲]** or **[▼]** several times until "bAK" appears.



- ④ Rotate **[VOL]** to select the desired bank.

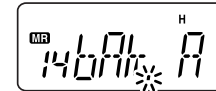

- ⑤ Push **[* ENT]** (or **[CLR]**) to assign the channel to the bank and return to regular memory condition.
- ⑥ Repeat steps ① to ⑤ to assign another memory channel to the same or another bank.

NOTE: Display type setting (pgs. 20, 53) in INITIAL SET MODE must be selected "FR," otherwise the memory bank operation cannot be performed.

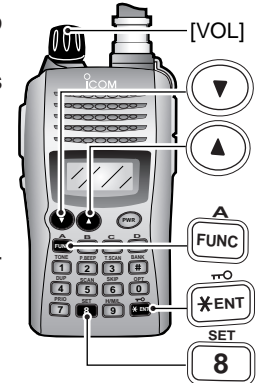

■ Transferring bank contents

Contents of programmed memory banks can be cleared or transferred to another bank.

/// INFORMATION: Even if the memory bank contents are cleared, the memory channel contents still remain programmed.

- ① Select the desired bank contents to be transferred or erased.
 - Push **[MR]** to select memory mode.

- Push **[FUNC]** and **[BANK](#)**, then rotate **[VOL]** to select the desired memory bank.
 - Bank indicator blinks.

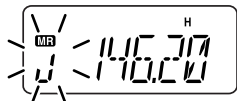

- Push **[* ENT]** (or **[CLR]**) to select the bank then push **[▲]** and **[▼]** to select the desired contents.
 - Bank indicator stops blinking.

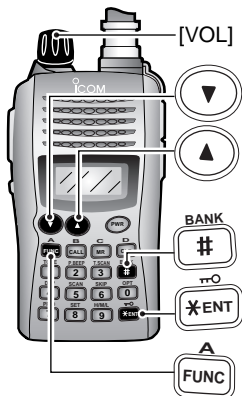

- ② Push **[FUNC]** and **[SET](8)** to enter SET MODE.
- ③ Push **[▲]** or **[▼]** several times until "bAk" appears.
 - Bank indicator appears.



- ④ Rotate **[VOL]** to select the desired bank to receive the transferred information or erase the bank contents.
 - Select "—" indication when erasing the contents from the bank.
- ⑤ Push **[* ENT]** (or **[CLR]**) to transfer or erase, and return to regular memory mode.
- ⑥ Repeat steps ① to ⑤ for transferring or erasing an another bank's contents.

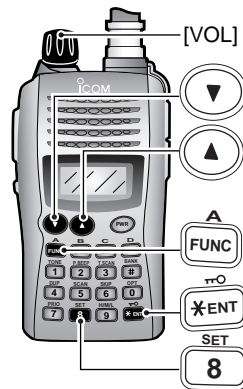

■ Programming a DTMF code sequence

The transceiver has 16 DTMF memory channels (d0 to dF) for storage of often-used DTMF code sequence of up to 24 digits. DTMF memories are used to store phone numbers or control codes.

- ① Push **[FUNC]**, then push **[OPT](0)** to enter OPTION SET MODE.
 - Rotate **[VOL]** to select “dtm.OF,” if necessary.



- ② Push and hold **[OPT](0)** for 1 sec. to select the DTMF memory.
 - One of “d0” to “dF” appears.

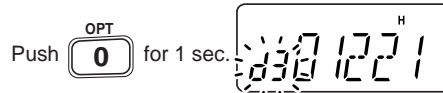

- ③ Rotate **[VOL]** to select the desired DTMF memory.
- ④ Push and hold **[OPT](0)** for 1 sec. to enter the DTMF programming mode.
 - “_____” appears.
 - Programmed memories can be cleared in this way.

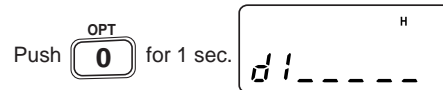

- ⑤ Enter the desired DTMF code sequence by pushing the digit keys, **[A]**, **[B]**, **[C]**, **[D]**, **[#]** and **[*]**, in the desired sequence.
 - A maximum of 24 digits can be input.
 - **[*]** enters tone “E”, **[#]** enters tone “F”
 - If a digit is mistakenly input, push **[MONI]** or **[PTT]** momentarily then repeat from step ①.



- ⑥ Push **[MONI]** or **[PTT]** to save the digits and exit the DTMF programming mode.
 - Programmed DTMF code sequence sounds when **[MONI]** is pushed.
 - Or after 24th digit is input, the transceiver automatically saves the digits and returns to step ②.

• DTMF memory indication

The DTMF memory consists of 5 pages that are 1st to 5th, 6th to 10th, 11th to 15th, 16th to 20th and 21st to 24th digits.

• 1st page indication



• 2nd page indication

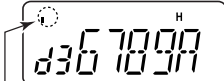

Appears

• 3rd page indication

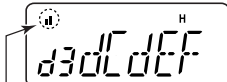

Appears

• 4th page indication

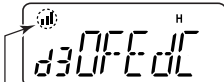

Appears

• 5th page indication

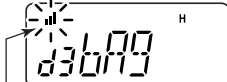

Blinks

■ Transmitting a DTMF code sequence

◇ Using a DTMF memory channel

- ① Push **[FUNC]**, then push **[OPT](0)** to enter OPTION SET MODE.
 - Rotate **[VOL]** to select “dtm.OF,” if necessary.



- ② Push and hold **[OPT](0)** for 1 sec. to select the DTMF memory.

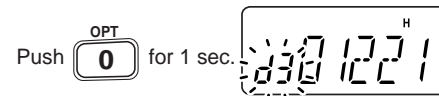

- ③ Rotate **[VOL]** to select the desired memory.
- ④ Push **[MONI]** or **[PTT]** to exit the DTMF memory mode.
 - Selected DTMF code sequence sounds when **[MONI]** is pushed.
- ⑤ While pushing **[PTT]**, push **[MONI]** to transmit the selected DTMF memory.
 - After the DTMF code sequence is transmitted, the transceiver returns to receive automatically.

◇ Manual DTMF code transmission

While pushing [PTT], push digit keys, [A], [B], [C], [D], [#] and [*] to transmit a DTMF code sequence manually.

- [*] transmits tone “E”, [#] transmits tone “F.”

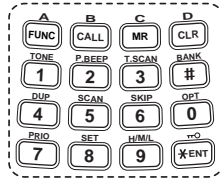

■ DTMF transmission rate

USING INITIAL SET MODE

When slow DTMF transmission rates are required with DTMF memory transmission (as for some repeaters), the transceiver’s rate of DTMF transmission can be adjusted.

- ① While pushing and holding [▲] and [▼], turn the power ON to enter INITIAL SET MODE.
- ② Push [▲] or [▼] several times until “dtd” appears.
- ③ Rotate [VOL] to select the desired DTMF transmission rate.

- Four rates are available: “1” (100 msec. intervals) is the fastest; “5” (500 msec. intervals) is the slowest.

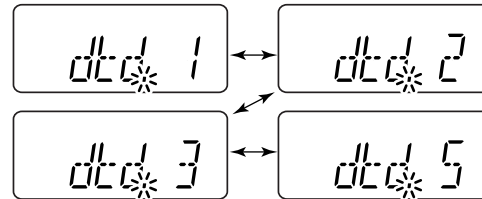
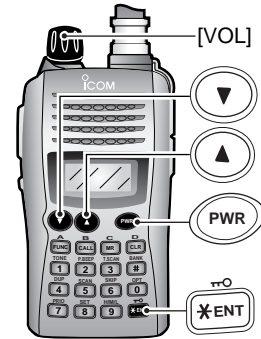

- ④ Push [* ENT] (or [CLR]) to exit INITIAL SET MODE.

Scan types

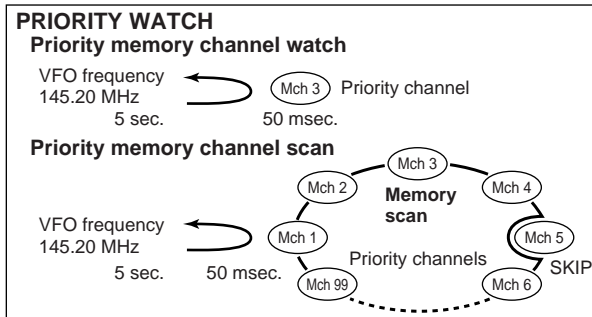
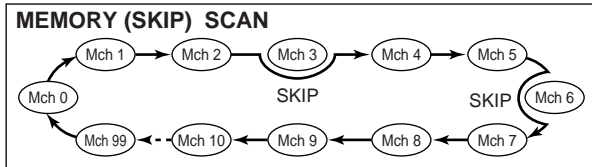
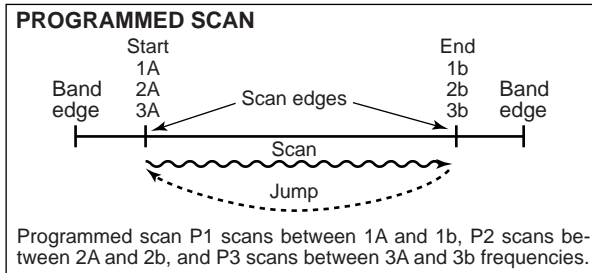

Programmed scan

Programmed scan repeatedly scans between two user programmed frequencies (memory channels “1A–3A” and “1b–3b”) or scans between upper and lower band edges. This scan is useful for checking for signals within a specific frequency range such as repeater output frequencies, etc. Scans between lower (start) and high (stop) frequency.

- ① Push **[CLR]** to select VFO mode, if necessary.
- ② Push **[FUNC]** and **[SCAN]**(5) to start a scan.



- ③ Push **[FUNC]** and **[SET]**(8) several times to select the desired scan edge, “P1,” “P2,” “P3” or “AL.”
 - “AL” for full scan, “P1,” “P2” and “P3” for programmed scan between the programmed scan edge channels as “1A”–“1b,” “2A”–“2b” and “3A”–“3b.”
 - To change the scan direction, push **[▲]** or **[▼]**.
 - When **[VOL]** is assigned as tuning dial, rotate **[VOL]** to change the scan direction. (pgs. 18, 53)



- ④ Push **[CLR]** to stop the scan.

NOTE: Scan edges, 1A–3A/1b–3b, must be programmed in advance. Program them in the same manner as regular memory channels. (p. 27)
 If identical frequencies are programmed into the scan edges, programmed scan will not proceed.

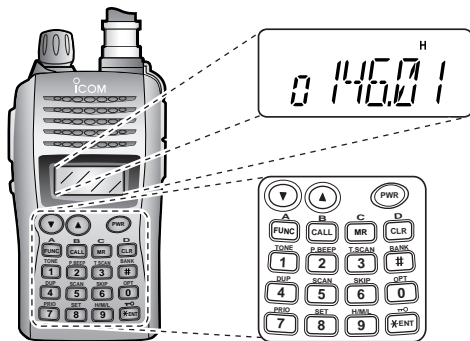

Memory scan

Memory scan repeatedly scans all programmed memory channels, except those set as skip channels.

- ① Push **[MR]** to select memory mode, if necessary.
 - “**MR**” appears.
 - See below to select bank scan.
- ② Push **[FUNC]** and **[SCAN]**(5) to start the scan.
 - To change the scan direction, push **[▲]** or **[▼]**.
 - When **[VOL]** is assigned as tuning dial, rotate **[VOL]** to change the scan direction. (pgs. 18, 53)

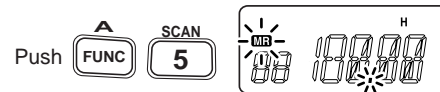

- ③ Push **[CLR]** to stop the scan.

• **Bank scan** — Select the desired bank in step ① above.

- ① Push **[FUNC]** and **[BANK]**(#) to select memory bank mode.

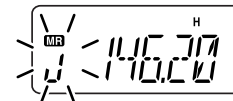

- ② Rotate **[VOL]** to select the desired bank, A to J.
- ③ Push **[* ENT]** (or **[CLR]**) to select the bank.

8 SCAN OPERATION

■ Skip channels

In order to speed up the scan rate, you can select memory channels you don't wish to scan as skip channels.

- ① Push **[MR]** to select memory mode, if necessary.
 - “MR” appears.
- ② Select a memory channel to set as a skip channel.
- ③ Push **[FUNC]** and **[SKIP]**(6) to toggle the skip setting ON and OFF.
 - “SKIP” appears when the channel is set as a skip channel.

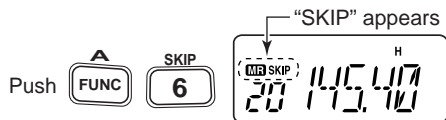

■ Scan resume condition

USING SET MODE

When a signal is received during scanning, the scan resume condition determines what action the transceiver takes. The transceiver has 2 scan resume conditions available as illustrated below. Use **SET MODE** to select the one which best suits your needs.

- ① Push **[FUNC]**, then push **[SET]**(8) to enter **SET MODE**.
- ② Push **[▲]** or **[▼]** several times until “SCP” or “SCt” appears.
- ③ Rotate **[VOL]** to select the desired scan resume condition.

• **Pause scan:**

When receiving a signal, scan pauses on the signal until it disappears. Resumes 2 sec. after the signal disappears.



Pause scan

• **Timer scan:**

When receiving a signal, scan pauses on the signal for 5 sec., 10 sec. or 15 sec., then resumes.



Timer scan

- ④ Push **[* ENT]** (or **[CLR]**) to set and exit **SET MODE**.

■ Priority watch

Priority watch checks for signals on “priority channels” while operating on a VFO frequency.

◇ Memory or call channel watch

While operating on a VFO frequency, memory or call channel watch monitors for signals in the selected memory or call channel every 5 sec.

- ① Select the desired memory channel or the call channel.
- ② Push **[CLR]** to select VFO mode.
- ③ Push **[FUNC]**, then push **[PRIO](7)** to start watching.
 - VFO is displayed, then the decimal point “.”, on the frequency readout blinks.
 - The priority channel is monitored every 5 sec.
 - When the signal is detected on the priority channel, the watching is suspended according to the setting of the scan resume condition.

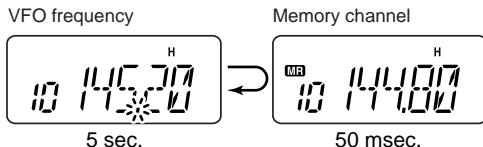

- ④ Push **[CLR]** to stop watching.

◇ Memory scan watch

While operating on a VFO frequency, memory scan watch monitors for signals in each memory channel in sequence, every 5 sec.

- ① Push **[MR]** to select memory mode, if necessary.
 - “MR” appears.
- ② Push **[FUNC]**, then push **[SCAN](5)** to start the memory scan.
- ③ Push **[FUNC]**, then push **[PRIO](7)** to start the watching.
 - VFO is displayed, then the decimal point “.”, on the frequency readout blinks.
 - When the signal is detected on the priority channel, the watching is suspended according to the setting of the scan resume condition.

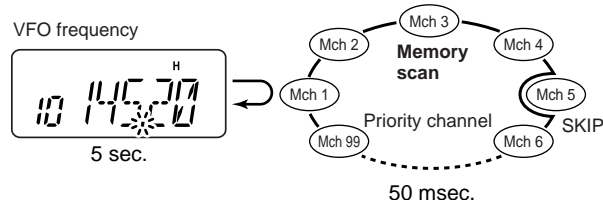

- ④ Push **[CLR]** to stop the watching.

■ Tone squelch

◇ Operation

The tone squelch opens only when receiving a signal containing a matching subaudible tone. You can wait for calls from group members using the same tone and not hear other signals.

- ① Set the operating frequency.
 - Set the volume and squelch to the desired level as the normal operation.
- ② Set the desired subaudible tone in SET MODE.
 - See page 40 for programming.
- ③ Push **[FUNC]**, then push **[TONE](1)**.
 - Repeat several times until “▶” appears when selecting CTCSS, or “Ⓜ” appears when selecting DTCS.

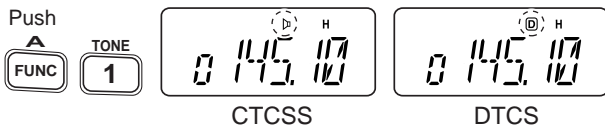

- ④ When the received signal includes a matching tone, squelch opens and the signal can be heard.
 - When the received signal's tone does not match, tone squelch does not open, however, the S-indicator shows signal strength.
 - To open the squelch manually, push and hold **[MONI]**.
- ⑤ Transmit in the normal way.
- ⑥ To cancel the tone squelch, push **[FUNC]** and **[TONE](1)**.
 - Repeat several times until “▶” or “Ⓜ” disappears.

NOTE: The transceiver has 50 tone frequencies and consequently their spacing is narrow compared to units having 38 tones. Therefore, some tone frequencies may receive interference from adjacent tone frequencies. To prevent interference from adjacent tone frequencies, using the frequencies as in the following table, is recommended.

• Recommended CTCSS frequencies (Unit: Hz)

67.0	79.7	94.8	110.9	131.8	156.7	186.2	225.7
69.3	82.5	97.4	114.8	136.5	162.2	192.8	233.6
71.9	85.4	100.0	118.8	141.3	167.9	203.5	241.8
74.4	88.5	103.5	123.0	146.2	173.8	210.7	250.3
77.0	91.5	107.2	127.3	151.4	179.9	218.1	

• Recommended DTCS codes

023	051	114	143	174	251	315	371	445	532	631	723
025	054	115	152	205	261	331	411	464	546	632	731
026	065	116	155	223	263	343	412	465	565	654	732
031	071	125	156	226	265	346	413	466	606	662	734
032	072	131	162	243	271	351	423	503	612	664	743
043	073	132	165	244	306	364	431	506	624	703	754
047	074	134	172	245	311	365	432	516	627	712	

◇ Setting subaudible tones for tone squelch operation

Separate tone frequencies can be selected for tone squelch operation rather than repeater operation (the same range of tones is available— see right below). Like the repeater tones, these are set in SET MODE.

- ① Select VFO or memory channel.
- ② Push **[FUNC]**, then push **[SET]**(8) to enter SET MODE.
- ③ Push **[▲]** or **[▼]** several times until “Ct” appears when selecting CTCSS, or “dt” appears when selecting DTCS.
 - “▷” blinks when selecting CTCSS, or “@” blinks when selecting DTCS.

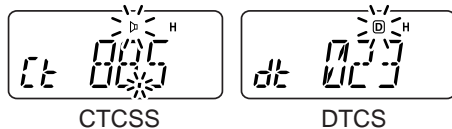

- ④ Rotate **[VOL]** to select the desired subaudible tone.
- ⑤ Push **[*ENT]** (or **[CLR]**) to program the selected tone and exit SET MODE.
 - The recommended CTCSS frequencies or DTCS codes are shown at previous page.

When SET MODE is selected from memory mode.

The tone squelch frequency is not stored in the selected memory channel unless you follow steps ⑥ and ⑦.

- ⑥ Push **[FUNC]**, then push and hold **[MR]** for 1 sec. to transfer the contents to VFO.
 - 3 beeps are emitted.
 - VFO mode is selected automatically.
- ⑦ Push **[FUNC]**, then push and hold **[MR]** for 1 sec.
 - 3 beeps are emitted.

• Available CTCSS tone frequency (unit: Hz)

67.0	85.4	107.2	136.5	165.5	186.2	210.7	254.1
69.3	88.5	110.9	141.3	167.9	189.9	218.1	
71.9	91.5	114.8	146.2	171.3	192.8	225.7	
74.4	94.8	118.8	151.4	173.8	196.6	229.1	
77.0	97.4	123.0	156.7	177.3	199.5	233.6	
79.7	100.0	127.3	159.8	179.9	203.5	241.8	
82.5	103.5	131.8	162.2	183.5	206.5	250.3	

• Available DTCS codes

023	053	116	155	225	261	325	371	452	516	627	731
025	054	122	156	226	263	331	411	454	523	631	732
026	065	125	162	243	265	332	412	455	526	632	734
031	071	131	165	244	266	343	413	462	532	654	743
032	072	132	172	245	271	346	423	464	546	662	754
036	073	134	174	246	274	351	431	465	565	664	
043	074	143	205	251	306	356	432	466	606	703	
047	114	145	212	252	311	364	445	503	612	712	
051	115	152	223	255	315	365	446	506	624	723	

■ Pocket beep operation

This function listens for subaudible tones and can be used as a “common pager” to inform you that someone has called when you were away from the transceiver.

◇ Waiting for a call from a specific station

- ① Set the operating frequency.
- ② Set the desired CTCSS tone frequency or DTCS code in SET MODE.
 - See p. 40 for programming details.
- ③ Push **[FUNC]**, then push **[TONE](1)**.
 - Repeat several times until “▶” appears when CTCSS, or “Ⓣ” appears when DTCS is selected.

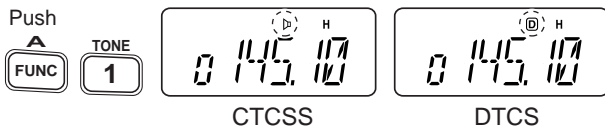

- ④ Push **[FUNC]**, then push **[P.BEEP](2)** to activate the pocket beep function.
 - “μ” appears.



- ⑤ When a signal with the matching tone is received, the transceiver emits beep tones and blinks “μ.”
 - Beep tones sound for 30 sec. and “μ” blinks. To stop the beeps manually, push any key. “μ” continues blinking until step ⑥ is operated.

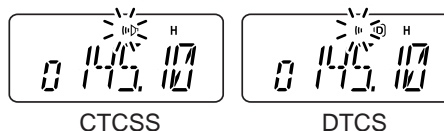

- ⑥ Push **[PTT]** to answer.
 - “μ” disappears and cancels the pocket beep function automatically.

■ Tone scan

By monitoring a signal on a repeater, or using pocket beep or tone squelch function, you can determine the tone frequency necessary to access a repeater or open the squelch.

- ① Set the frequency to be checked for a tone frequency or code.
- ② Push **[FUNC]**, then push **[TONE](1)**.
 - Repeat several times to select the type of tone to be scanned. (One of “♪”, “▷” or “⊙” appears)
 - Tone scan may be used even if the tone condition or type is not selected.

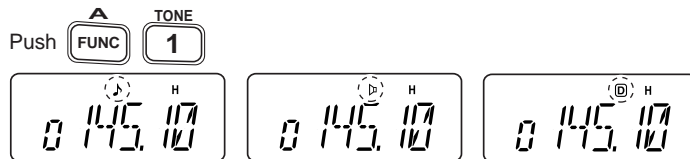

- ③ Push **[FUNC]**, then push **[T.SCAN](3)** to start the tone scan.
 - To change the scanning direction, push **[▲]** or **[▼]**.

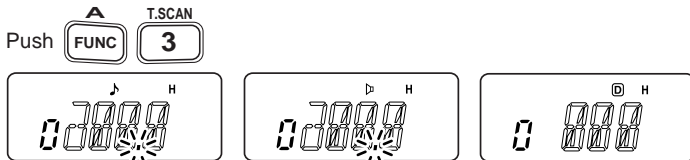

- ④ When the CTCSS tone frequency or DTCS code is matched, the squelch opens and the tone frequency or code is temporarily programmed into the selected mode such as memory or call channel.

- The tone scan pauses when a CTCSS tone frequency or 3-digit DTCS code is detected.
- The decoded CTCSS tone frequency or 3-digit DTCS code is used for the tone encoder or tone encoder/decoder depending on the selected tone condition or type in step ②.

- No indication : Cannot be used for operation.
- “♪” : CTCSS tone encoder
- “▷” : CTCSS tone encoder/decoder
- “⊙” : DTCS tone encoder/decoder

- ⑤ Push **[CLR]** to stop the scan.

■ Pager function

This function uses DTMF codes for paging and can be used as a “message pager” to confirm you of a caller’s identification even when you leave the transceiver temporarily unattended.

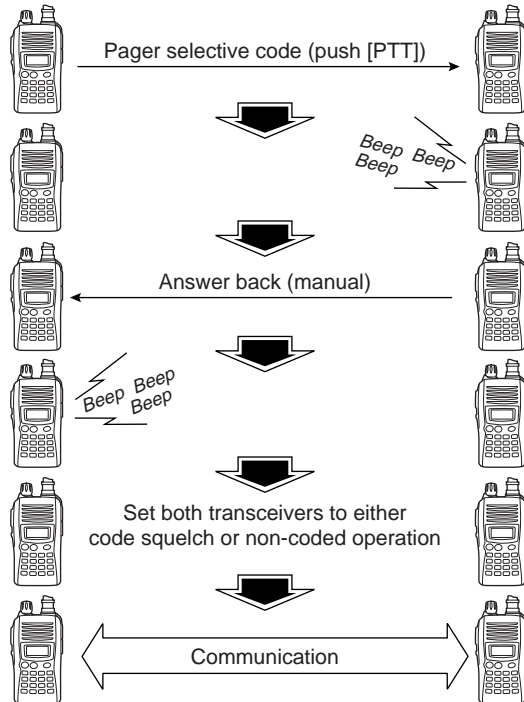

■ Code programming

◇ Before programming

The pager and code squelch functions require ID codes and a group code. These codes are 3-digit DTMF codes and must be written into the code channels before operation.

- ① Decide the ID code of each transceiver and a group code for your group.
- ② Decide whether you want to return to normal operation or code squelch operation after a connection is made.
- ③ Program the ID code, group code and transmit codes (other station’s codes) as below.

◇ Code channel assignment

ID OR GROUP CODE	CODE CHANNEL NUMBER	“RECEIVE ACCEPT” OR “RECEIVE INHIBIT”
Your ID code	0	“Receive accept” only
Other parties’ ID code	1–6	“Receive inhibit” should be programmed in each channel.
Group code	One of 1–6	“Receive accept” must be programmed in one channel.
Memory space*	P	“Receive inhibit” only.

*Channel CP automatically memorizes an ID code when receiving a pager call. The contents in channel CP cannot be changed manually.

◆ Code programming

Your ID code **MUST** be programmed into code channel C0. Up to 6 transmit codes (codes that you transmit) are programmable into code channels, C1 to C6, if required.

- 1 Push **[FUNC]**, then push **[OPT](0)** to enter OPTION SET MODE.

- Rotate **[VOL]** to select “dtm.PG” or “dtm.CS,” if “dtm.OF” appears.

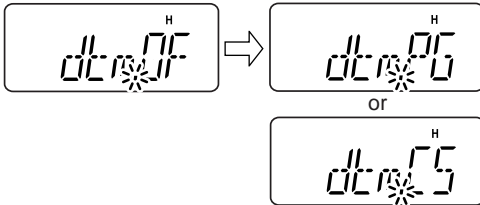

- 2 Push and hold **[OPT](0)** for 1 sec. to enter the code selection mode.

- One of either “CP” or “C0” to “C6” blinks.
- “C0” is your ID code and “C1” to “C6” are transmit codes.



- 3 Rotate **[VOL]** (or push **[▲]/[▼]**) to select code channel C0.
- Each transceiver should have a different ID code.

- 4 Enter the desired 3-digit ID code via the keypad.

- 5 Rotate **[VOL]** (or push **[▲]/[▼]**) to select a transmit code channel from C1 to C6.

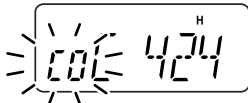

- 6 Enter the desired 3-digit transmit code via the keypad.

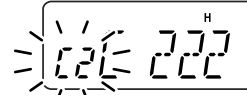

- 7 Push **[FUNC]**, then push **[SKIP](6)** to set the channel to “receive inhibit” or “receive accept.”

- When “receive inhibit” is set, “SKIP” appears as below.
- Code channel C0 cannot be set as “receive inhibit.”
- See the table for “receive accept” and “receive inhibit” details (p. 43).

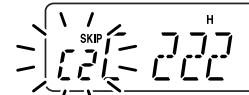

- 8 Repeat steps 5 and 6 to set additional transmit code channels, if desired.

- 9 Push **[* ENT]** (or **[CLR]**) to exit code selection mode.

• Receive accept/receive inhibit

- “Receive accept” (“SKIP” indicator does not appear) accepts pager calls when the transceiver receives a signal with a code the same as that in the code channel.
- “Receive inhibit” (“SKIP” indicator appears) ignores calls even when the transceiver receives a code the same as that in the code channel. Transmit codes should therefore be programmed for “receive inhibit,” otherwise the transceiver will not reject unnecessary calls.

■ Pager operation

◇ Calling a specific station

- ① Program the code channel in advance (p. 44).
- ② Set the operating frequency.
 - Set the volume and squelch to the desired level as in normal operation.
- ③ Push **[FUNC]**, then push **[OPT](0)**.
 - Rotate **[VOL]** to select “dtm.PG,” if “dtm.CS” or “dtm.OF” appears.



- ④ Select the desired transmit code channel:
 - ➔ Push and hold **[OPT](0)** for 1 sec. to enter the code selection mode.
 - ➔ Rotate **[VOL]** (or push **[▲]/[▼]**) to select the desired code channel.
 - ➔ Push **[* ENT]** (or **[CLR]**) to return to previous mode.
 - 100 MHz digit shows “P.”

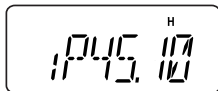

- ⑤ Push **[PTT]** to transmit the pager code.
- ⑥ Wait for an answer back.
 - When the transceiver receives an answer back code, the function display shows the other member’s ID or group code.

- ⑦ After confirming a connection, push **[FUNC]** and **[OPT](0)** to enter **OPTION SET MODE**, then rotate **[VOL]** to select the code squelch operation “dtm.CS,” or non-selective calling system “dtm.OF.”
 - DO NOT push any digit keys while code channels C0 to C6 are displayed, otherwise code channel contents will be changed.
- ⑧ Communicate with the other party as normal: push **[PTT]** to transmit; release to receive.

◇ Waiting for a call from a specific station

- ① Set the operating frequency.
- ② Push **[FUNC]**, then push **[OPT](0)**.
 - ➔ Rotate **[VOL]** to select “dtm.PG,” if “dtm.CS” or “dtm.OF” appears.
 - ➔ Push **[* ENT]** (or **[CLR]**) to return to previous mode.
 - 100 MHz digit shows “P.”
- ③ Wait for a call.
 - When receiving a call, the caller’s ID or group code appears as shown at next page.
 - DO NOT push any digit keys while code channels C0 to C6 are displayed, otherwise code channel contents will be changed.
- ④ Push **[PTT]** to send an answer back call and display the operating frequency.
- ⑤ After confirming a connection, push **[FUNC]** and **[OPT](0)** to enter **OPTION SET MODE**, then rotate **[VOL]** to select the code squelch operation “dtm.CS,” or non-selective calling system “dtm.OF.”

• PERSONAL CALLS

This display appears when you are called with your ID code and the calling station's ID code is 123.



"CP" and "H" blink.

• GROUP CALLS

This display appears when you are called with the group code, 888, and 888 has been programmed into code channel C6.



• ERROR INFORMATION

When the transceiver receives an incomplete code, "E" and previously received code appear.

Previously received code.

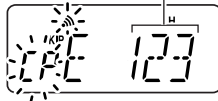

During channel number indication (described on page 20)

To use these functions in channel number indication, the pager/code squelch setting must be programmed with other memory contents before selecting channel number indication.

■ Code squelch

When using code squelch you will only receive calls from stations which know your ID or group code. A 3-digit code is sent each time [PTT] is pushed in order to open the receiving station's code squelch prior to voice transmission.

- ① Set the operating frequency.
 - Set the volume and squelch to the desired level as in normal operation.
- ② Push [FUNC], then push [OPT](0).
 - Rotate [VOL] to select "dtm.CS," if "dtm.PG" or "dtm.OF" appears.
- ③ Select the desired transmit code channel:
 - Push and hold [OPT](0) for 1 sec. to enter code selection mode.
 - Rotate [VOL] (or push [▲]/[▼]) to select the desired code channel.
 - Push[* ENT] (or [CLR]) to exit code selection mode and return to previous mode.
 - 100 MHz digit shows "C."

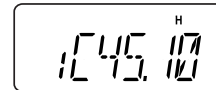

- ④ Operate the transceiver in the normal way (push [PTT] to transmit; release [PTT] to receive).
- ⑤ To cancel the code squelch, push [FUNC] and [OPT](0), then rotate [VOL] to select "dtm.OF."
 - 100 MHz digit shows "1" when the function is cancelled.

11 SET MODES

■ SET MODE

◇ Entering SET MODE

- ① Push [FUNC], then push [SET](8) to enter SET MODE.
- ② Push [▲] or [▼] to select the desired item.
- ③ Rotate [VOL] to select the condition/value.
 - To exit SET MODE, push [*ENT] (or [CLR]).

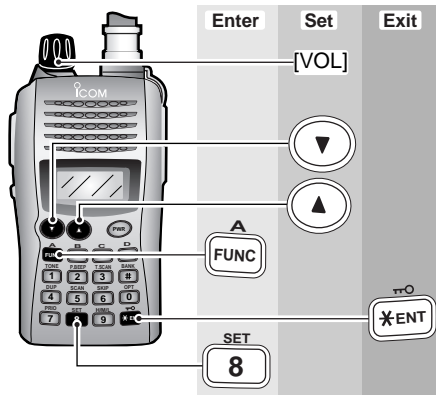

NOTE: When the display type setting (pgs. 16, 65) in INITIAL SET MODE is selected other than “FR” (“CH” or “nm”) and accessing SET MODE from memory mode, most of set mode items are restricted.

◇ Repeater tone frequency

Selects tone encoder frequency for accessing a repeater, etc. from one of 50 available frequencies.

- 67.0–254.1 Hz (50 tones): 88.5 Hz (default)



◇ Tone squelch frequency

Selects frequency for tone squelch or pocket beep operation from one of 50 available frequencies.

- 67.0–254.1 Hz (50 tones): 88.5 Hz (default)



• Available subaudible tone frequencies

67.0	79.7	94.8	110.9	131.8	156.7	171.3	186.2	203.5	229.1
69.3	82.5	97.4	114.8	136.5	159.8	173.8	189.9	206.5	233.6
71.9	85.4	100.0	118.8	141.3	162.2	177.3	192.8	210.7	241.8
74.4	88.5	103.5	123.0	146.2	165.5	179.9	196.6	218.1	250.3
77.0	91.5	107.2	127.3	151.4	167.9	183.5	199.5	225.7	254.1

◇ DTCS code

Selects DTCS (both encoder/decoder code) for DTCS squelch operation. Total of 104 codes are available.

- 023–754: 023 (default)

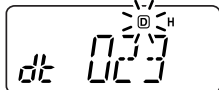

◇ DTCS polarity

Selects DTCS polarities for transmission and reception from “nn (default),” “nR,” “Rn” and “RR.” (n: normal/R: reverse)

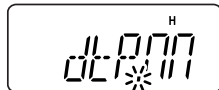

◇ Tuning step

Selects tuning step from 5, 10, 12.5, 15, 20, 25, 30 and 50 kHz for [▲]/[▼] or [VOL] (When [VOL] is assigned as tuning dial) operation. (default value may differ depending on transceiver types and versions)

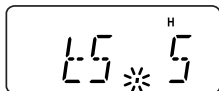

◇ Offset frequency

Sets the duplex offset frequency within 0 to 20 MHz range. During duplex (repeater) operation, transmit frequency (or receive when reverse function is set to ON) shifts the set frequency. (default value may differ depending on transceiver types and versions)



◇ Reverse function

Turns the reverse function ON and OFF (default).

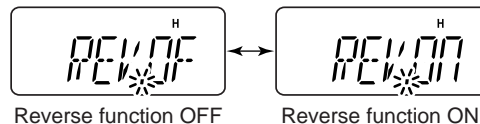

11 SET MODES

◇ Scan pause timer

Selects the scan pause time from SCt.5, SCt.10, SCt.15 and SCP. 2. When receiving signals, the scan pauses according to the scan pause time.

- SCt. 5/10/15 : Scan pauses for 5/10/15 sec.
(default: SCt.15)
- SCP. 2 : Scan pauses until the signal disappears. Resumes 2 sec. after the signal disappears.



◇ Function key timer

Selects the function indicator display timer (when pushed [FUNC]) from F0.At, F1.At, F2.At, F3.At and F.m.

- F0.At : "F" disappears immediately after secondary function is operated. (default)
- F1/2/3.At : "F" disappears after 1/2/3 sec. after secondary function is operated.
- F.m : "F" appears until [FUNC] is pushed again.

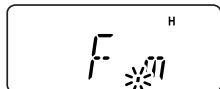

◇ LCD backlight

Selects LCD backlight lighting condition from auto, ON and OFF.

- LIG.At : Lights when any key except [PTT] is pushed. (default)
- LIG.ON : Lights continuously while the transceiver is powered ON.
- LIG.OF : Never lights.

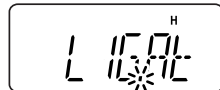

◇ Transmission permission

Turns transmission permission ON and OFF. This function can be set for each memory and call channel, independently.

- tX.On : Transmission is permitted. (default)
- tX.OF : Transmission is inhibited.

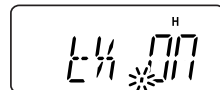

◇ Memory bank setting

Sets the desired memory bank (A to J and OFF) to assign the regular memory channels.

This item appears when SET MODE is accessed from memory mode only.



◇ Memory bank link function

Sets the memory bank link function ON and OFF (default). The link function provides continuous banks scan, scanning all contents in the selected banks during bank scan.

This item appears when SET MODE is accessed from memory mode only.



• Bank link setting

- ① Rotate [VOL] to select the memory bank link function ON.
- ② Push [▲] or [▼] to select the desired bank to be linked.
 - bLA: Bank A, bLb: Bank B, bLC: Bank C, bLd: Bank D, bLE: Bank E, bLF: Bank F, bLG: Bank G, bLH: Bank H, bLI: Bank I, bLJ: Bank J
- ③ Rotate [VOL] to "ON" to link the bank.
- ④ Repeat steps ② and ③ to link other banks.

◇ Weather alert function

USA version only

Turns weather alert function ON and OFF (default).



11 SET MODES

■ INITIAL SET MODE

AT POWER ON

The INITIAL SET MODE is accessed at power on and allows you to set seldom-changed settings. In this way, you can “customize” transceiver operations to suit your preference and operating style.

◇ Entering INITIAL SET MODE

- ① While pushing and holding [▲] and [▼], turn power ON.
- ② Push [▲] or [▼] to select the desired item.
- ③ Rotate [VOL] to select the condition or value.
 - To exit INITIAL SET MODE, push [* ENT] (or [CLR]).

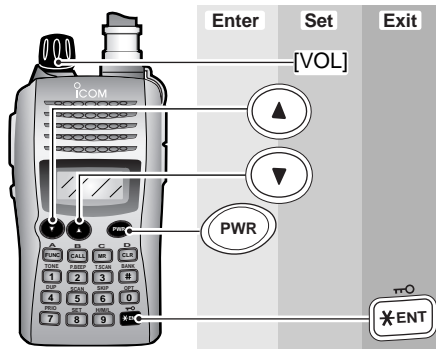

◇ Key-touch beep

Turns key-touch beep emission ON (Beep level 1 to 3) or OFF. (default: 3)



/// **NOTE:** The pocket beep level (Beep level 1 to 3 or OFF) also changes as this setting.

◇ Time-out timer

To prevent accidental prolonged transmission, etc., the transceiver has a time-out timer. This function cuts a transmission OFF after 1–30 min. of continuous transmission. This timer can be cancelled.

- tOt.OFF : The time-out timer is turned OFF.
- tOt. 1–30: The transmission is cut OFF after the set period elapses. (default: 3)

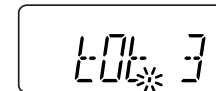

/// **BE CAREFUL!** The transceiver will become hot when this time-out timer function is turned OFF and transmission is made for long periods.

/// **NOTE:** When the battery pack (BP-227) becomes hot from continuous transmission, etc., the battery’s protection circuit may activate to protect the battery itself and then shut off the transceiver power until it has cooled down.

◆ Auto repeater

USA version only

The auto repeater function automatically turns ON or OFF the duplex operation and tone encoder. The offset and repeater tone is not changed by the auto repeater function. Reset these frequencies, if necessary.

- RPt.OF : The auto repeater function is turned OFF.
- RPt.R1 : Activates for duplex only. (default)
- RPt.R2 : Activates for duplex and tone.

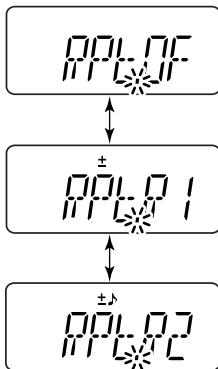

◆ Auto power-off

The transceiver can be set to automatically turn OFF after a specified period with a beep when no key operations are performed.

- 30 min., 1 hour, 2 hours and OFF (default) can be specified. The specified period is retained even when the transceiver is turned OFF by the auto power-off function. To cancel the function, select "POF.OF" in this SET MODE.



◆ Repeater lock-out

Selects lockout type from repeater, busy and OFF.

- RLO.OF : No lockout is activated. (default)
- RLO.RP : The repeater lockout is turned ON.
- RLO.bU : The busy lockout is turned ON.

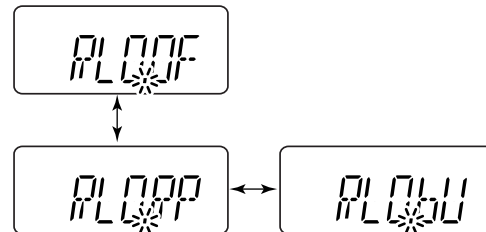

11 SET MODES

◆ Squelch delay

Selects squelch delay from short and long to prevent repeated opening and closing of the squelch during reception of the same signal.

- Sqt. S : The squelch closes in short delay. (default)
- Sqt. L : The squelch closes in long delay.



◆ DTMF rate

The rate at which DTMF memories send individual DTMF characters can be set to accommodate operating needs.

- 1: 100 msec. interval; 5.0 cps rate (default)
- 2: 200 msec. interval; 2.5 cps rate
- 3: 300 msec. interval; 1.6 cps rate
- 5: 500 msec. interval; 1.0 cps rate (cps=characters/sec.)

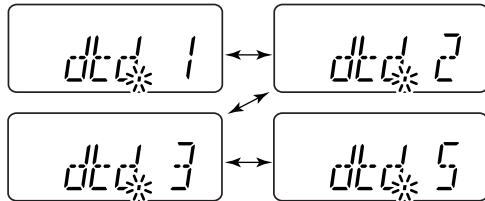

◆ Dial assignment

Selects [VOL] control action from volume and tuning dial.

- tOP.VO : AF volume (default)
- tOP.dl : Tuning dial

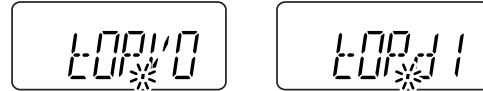

◆ Display type

Selects LCD indication type from frequency, channel number and channel names.

- dSP.FR : Shows frequency (default)
- dSP.CH : Shows channel number*
- dSP.nm : Shows channel names†

*Only memory channels can be selected.

†Frequency indication will be displayed when the selected memory channel has no programmed memory name.

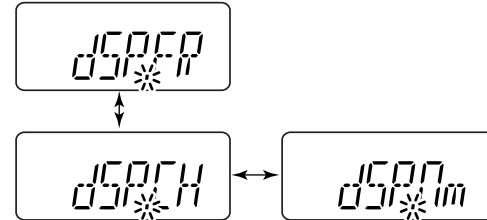

/// **NOTE:** When this setting is selected other than “FR” (“CH” or “nm”) and accessing SET MODE from memory mode, most of set mode items are restricted.

◇ LCD contrast

Selects LCD contrast from auto, high and low.

- LCd.At : Automatic (default)
- LCd.HI : High contrast
- LCd.LO : Low contrast

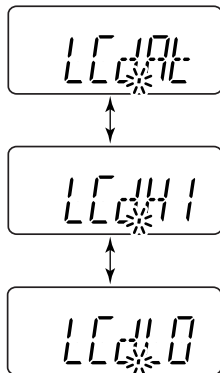

◇ Power save

Selects duty cycle for power save function from auto, 1:32, 1:16, 1:8, 1:2 and OFF.

- P-S.At : Duty cycle changes automatically. (default)
- P-S.32 : 1:32 duty cycle
- P-S.16 : 1:16 duty cycle
- P-S. 8 : 1:8 duty cycle
- P-S. 2 : 1:2 duty cycle
- P-S.OF : The power save function is turned OFF.



NOTE: During pager or code squelch operation (with UT-108), the active duty cycle is fixed 1:1 only (even for duty cycle settings other than OFF).

11 SET MODES

◇ Monitor key action

The monitor key, **[MONI]**, can be set as a 'sticky' key. When set to the sticky condition, each push of **[MONI]** toggles the monitor function ON and OFF.

- PU (Push) : Pushing and holding **[MONI]** to monitor the frequency. (default)
- HO (Hold) : Push **[MONI]** to monitor the frequency and push again to cancel it.



◇ Tuning speed acceleration

The tuning speed acceleration automatically speeds up the tuning speed when pushing and holding **[▲]** or **[▼]**, or rotating **[VOL]** rapidly.*

- S-S.At : The tuning speed acceleration is activated. (default)
- S-S.m : The tuning speed acceleration is not activated.

*When tuning dial is assigned with **[VOL]**.

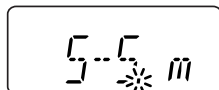
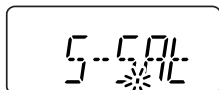

◇ Mic simple mode

Optional HM-75A required

This item turns the microphone simple mode ON and OFF. Microphone simple mode is used to change the function assignments for keys in the optional HM-75A REMOTE CONTROL SPEAKER-MICROPHONE as below. This assignment is convenient for 3-channel use of simple operation.

- mIC.n1 : Normal 1 (default)
- mIC.n2 : Normal 2
- mIC.Sm: Simple mode

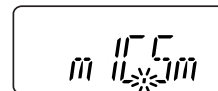
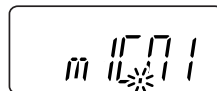

HM-75A key	Mode	NORMAL1	NORMAL2	SIMPLE
[A]	Freq. CH	[CALL] Null	[MONI]	[MONI]
[B]	Freq. CH	VFO/Memory Null	VFO/Memory Null	[CALL]
[▲]	Freq. CH	Freq. Up Memory CH Up	Freq. Up Memory CH Up	MR-00CH
[▼]	Freq. CH	Freq. Down Memory CH Down	Freq. Down Memory CH Down	MR-01CH

A 1750 Hz tone can be transmitted with the HM-75A operation.

➡ Push **[A]** while pushing **[PTT]**.

NOTE:

- Turn power OFF when connecting the HM-75A to the transceiver.
- VFO mode cannot be selected via the microphone when SIMPLE mode is selected.

◇ Battery protection function

Sets the Battery protection function from LI (Li-Ion) (default) and OFF.

LI(Li-Ion):

- The transceiver does not memorized the transceiver ON/OFF condition when battery is detached, and automatically returns to OFF condition even if you detach the battery with the transceiver ON condition. You are required to turn ON the transceiver by pushing **[PWR]** for every battery attach.
- Beep sounds when the attached battery is exhaustion.
 - The battery must be charged presently.

OFF : The transceiver memorizes the transceiver ON/OFF condition when battery is detached.







- NOTE:** This item **MUST** be set "LI" (Li-Ion) when the attaching battery is BP-227 (Li-Ion).

12 SET MODE INSPECTION

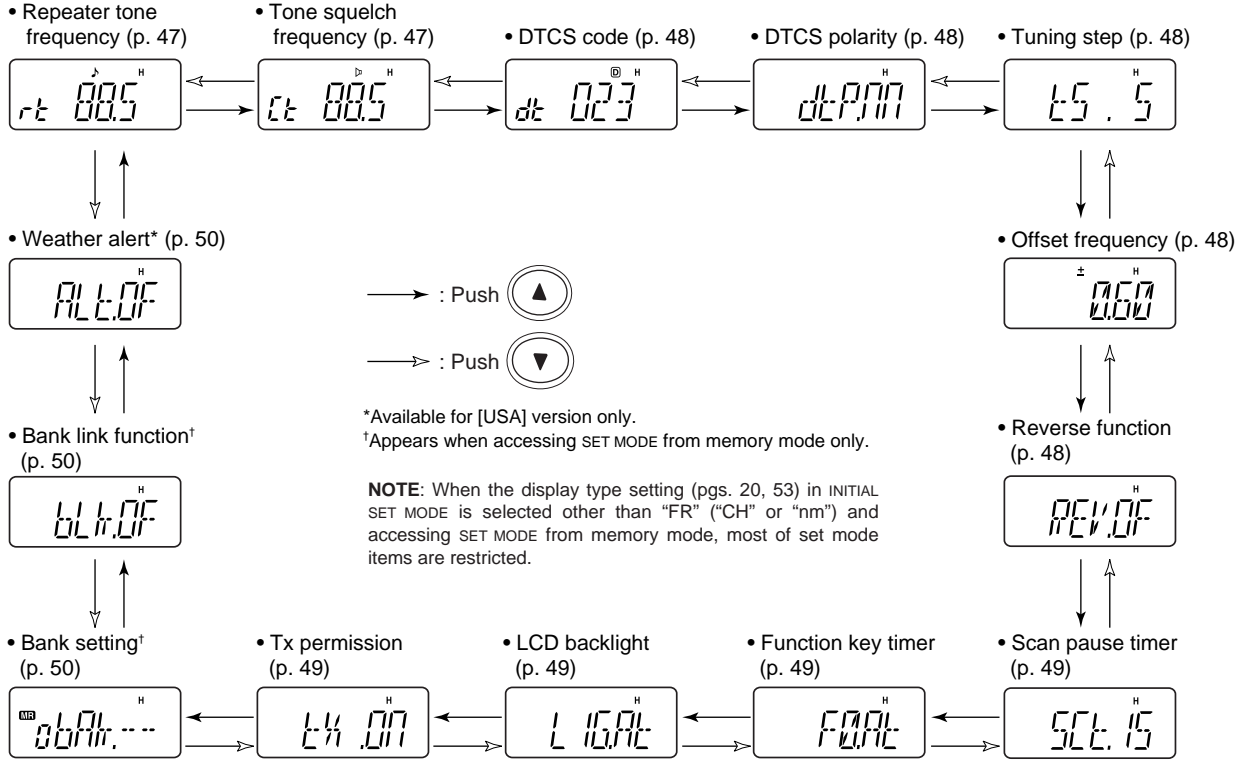
Push **FUNC**, then push **8** to enter SET MODE (p. 47).

SET MODE



While pushing and holding  , push  to enter INITIAL SET MODE (p. 51).

INITIAL SET MODE

- Key touch beep (p. 51)
- Time-out timer (p. 51)
- Auto repeater* (p. 52)
- Auto power-off (p. 52)
- Repeater lock-out (p. 52)

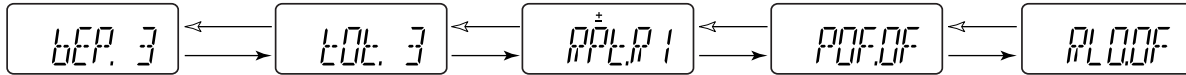

- Battery protection function (p. 56)



- Squelch delay (p. 53)

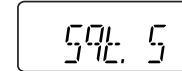

- Mic simple mode (p. 55)

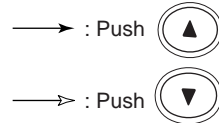
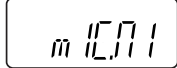

*Available for [USA] version only.

- DTMF rate (p. 53)

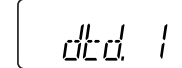

- Tuning speed acceleration (p. 55)

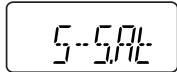

- Dial assignment (p. 53)

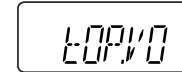

- Monitor key action (p. 55)

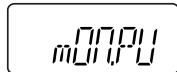

- Power save (p. 54)

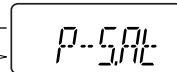

- LCD contrast (p. 54)

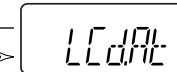

- Display type (p. 53)

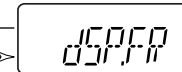

13 CLONING

Cloning allows you to quickly and easily transfer the programmed contents from one transceiver to another transceiver.

■ Transceiver-to-transceiver cloning

- ① Connect the OPC-474 CLONING CABLE to the [SP] jack of the master and sub-transceivers.
 - The master transceiver is used to send data to the sub-transceiver.

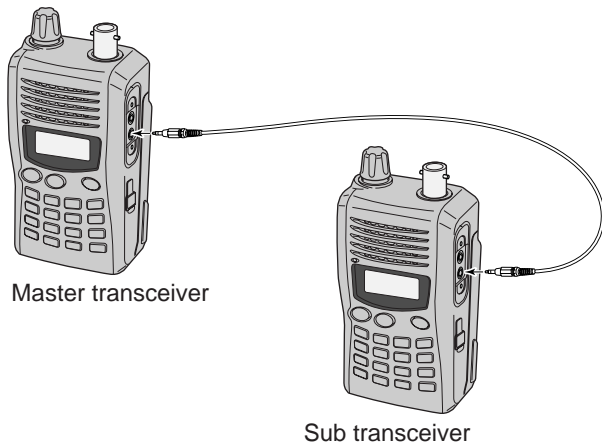

- ② While pushing [FUNC] and [▲], turn power ON to enter cloning mode (master transceiver only— power ON for sub-transceiver).
 - “CLONE” appears and the transceivers enter the clone standby condition.

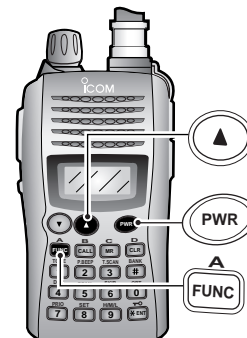
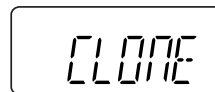

AT POWER ON

③ Push **[PTT]** on the master transceiver.

- “CL OU” appears in the master transceiver’s display and S-meter indicator shows that data is being transferred to the sub-transceiver.



- “CL In” appears automatically in the sub-transceiver’s display and S-meter indicator shows that data is being received from the master transceiver.



④ When cloning is finished, turn power OFF, then ON again to exit cloning mode.

NOTE: DO NOT push **[PTT]** on the sub-transceiver during cloning. This will cause a cloning error.

■ Cloning using a PC

Please refer to the HELP file that comes with CS-V85 CLONING SOFTWARE.

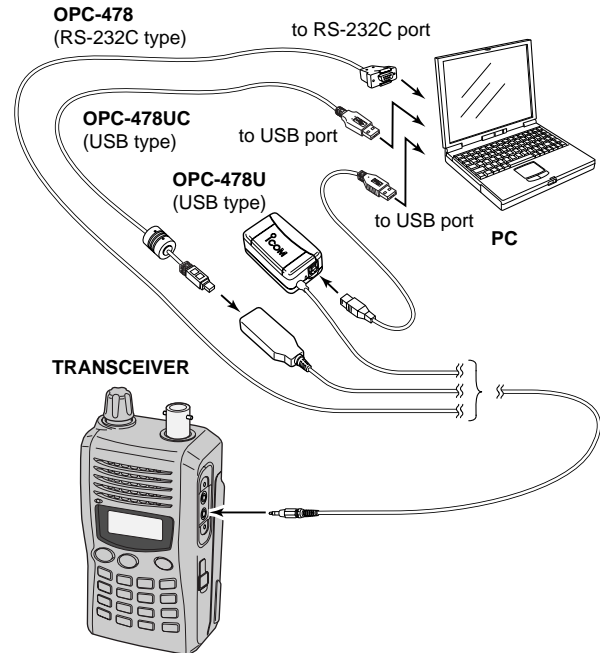

14 RESETTING FUNCTIONS

■ Partial reset

AT POWER ON

If you want to initialize the operating conditions (VFO frequency, VFO settings, set mode contents) without clearing the memory contents, a partial resetting function is available for the transceiver.

- ➔ While pushing [CLR], push and hold [PWR] for 1 sec. to partially reset.

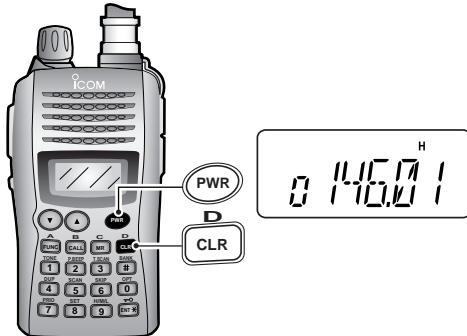

■ CPU reset

AT POWER ON

The function display may occasionally display erroneous information (e.g. when first applying power). This may be caused externally by static electricity or by other factors.

If this problem occurs, turn power OFF. After waiting a few seconds, turn power ON again. If the problem persists, perform the following procedure.

- Partial resetting is also available. See left for details.

/// IMPORTANT!:

Resetting the transceiver **CLEARs** all memory information and initializes all values in the transceiver.

- ➔ While pushing [MONI] and [CLR], push and hold [PWR] for 1 sec. to reset the CPU.

- "CLEAR" indicates, then initial display appears.

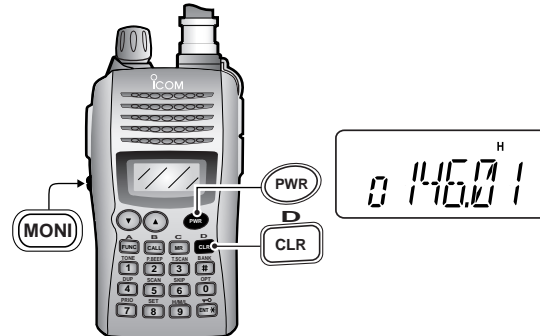

If your transceiver seems to be malfunctioning, please check the following points before sending it to a service center.

PROBLEM	POSSIBLE CAUSE	SOLUTION	REF.
No power comes ON.	<ul style="list-style-type: none"> The batteries are exhausted. The battery polarity is reversed. Battery's temperature protection circuit is activate. 	<ul style="list-style-type: none"> Replace the batteries or charge the battery pack. Check the battery polarity. Cool down the BP-227. 	pgs. 9, 13–15 p. 10 –
No sound comes from the speaker.	<ul style="list-style-type: none"> Volume level is too low. Different tone is selected with tone/DTCS squelch. 	<ul style="list-style-type: none"> Rotate [VOL] to suitable level. Check the tone using tone/DTCS scan. 	p. 19 p. 42
Transmitting is impossible.	<ul style="list-style-type: none"> The batteries are exhausted. 	<ul style="list-style-type: none"> Replace the batteries or charge the battery pack. 	pgs. 9, 13–15
No contact possible with another station.	<ul style="list-style-type: none"> Different tone is selected with tone/DTCS squelch. 	<ul style="list-style-type: none"> Check the tone/DTCS using tone scan. 	p. 42
Frequency can not be set.	<ul style="list-style-type: none"> The key lock function is activated. Memory mode or call channel is selected. 	<ul style="list-style-type: none"> Push [FUNC] then push and hold [↔](* ENT) for 1 sec. to cancel the function. Push [CLR] to set VFO mode. 	p. 20 p. 17
Program scan function can not start.	<ul style="list-style-type: none"> Memory mode or call channel is selected. Same frequencies are programmed both “*A” and “*b” of scan edge memory channel. 	<ul style="list-style-type: none"> Push [CLR] to set VFO mode. Programming different frequencies in “*A” and “*b” respectively. 	p. 17 p. 27
Memory scan function can not start.	<ul style="list-style-type: none"> VFO mode or call channel is selected. The programmed memory channel is only one. 	<ul style="list-style-type: none"> Push [MR] to set memory mode. Program more than 2 memory channels. 	p. 26 p. 27
The displayed frequency is erroneous.	<ul style="list-style-type: none"> The CPU malfunctioned. External factors caused a fault. 	<ul style="list-style-type: none"> Reset the transceiver. Remove and re-attach the battery pack or battery case. 	p. 61 p. 9
Can not charge the battery with BC-167A/D.	<ul style="list-style-type: none"> Turn the transceiver's power ON. 	<ul style="list-style-type: none"> Turn the transceiver's power OFF, then connect the BC-167A/D to charge. 	pgs. 13 ,17

16 OPTION

■ Optional UT-108 installation

- ① Remove the optional connector access cover (named 2251 OPT sheet).
 - Insert a screwdriver into the hollow of the chassis, then lift and take away the cover. (The removed cover cannot be used again.)

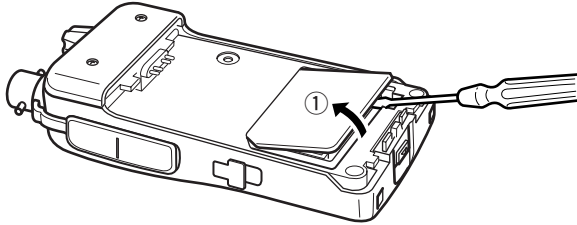

WARNING!
NEVER attempt to remove the optional connector cover using your finger nails, this may result in injury.

- ② Attach the optional unit. Insert the connector firmly to avoid a bad contact.
 - Remove the paper backing of the optional unit before installing.

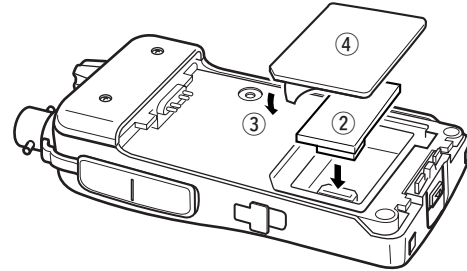

- ③ Remove the paper backing of 2251 OPT sheet supplied as an accessory.
- ④ Attach the new 2251 OPT sheet to the service window.
- ⑤ Program the necessary information from the transceivers keypad or using the cloning software, before operation.

■ General

- Frequency coverage : (unit: MHz)
 - USA Tx: 144–148/Rx: 136–174*1
 - Taiwan, Thailand, Korea Tx/Rx: 144–146
 - General (LM) Tx/Rx: 136–174*1
- *1: Guaranteed: 144–148 MHz range only
- Type of emission : FM
- Number of memory channels : 107 (incl. 6 scan edges and 1 call)
- Frequency resolution : 5, 10, 12.5, 15, 20, 25, 30, 50 kHz
- Operating temperature range : –10°C to +60°C; +14°F to +140°F
- Frequency stability : ±2.5 ppm
(–10°C to +60°C; +14°F to +140°F)
- Power supply requirement : Supplied (or optional) Icom's battery pack or 11.0 V±15% external DC power
- Current drain : (at 7.2 V DC: approx.)
 - Transmit
 - at 7 W (High) 2.6 A
 - at 4 W (Middle) 2.0 A
 - at 0.5 W (Low) 1.0 A
 - Receive
 - standby 80 mA
 - power save 30 mA
 - max. audio 250 mA
- Antenna connector : BNC (50 Ω)
- Dimensions (proj. not included) : 56(W) × 110(H) × 34.4(D) mm
27³²/₃₂(W) × 41¹³²/₃₂(H) × 1¹³²/₃₂(D) in
(with BP-227)
- Weight (approx.) : 310 g; 12.5 oz
(with BP-227 and Ant.)
165 g; 5.8 oz
(without battery pack and Ant.)

■ Transmitter

- Modulation system : Variable reactance frequency mod.
- Output power (at 7.2 V) :
 - [Thailand] 5.5 W/4 W/0.5 W (High/Mid/Low)
 - [Others] 7 W/4 W/0.5 W (High/Mid/Low)
- Max. frequency deviation : ±5.0 kHz
- Spurious emissions : Less than –60 dBc
- Microphone connector : 3-conductor 2.5 (d) mm (1/16")/2.2 kΩ

■ Receiver

- Receive system : Double-conversion superheterodyne
- Intermediate frequencies : 1st: 46.35 MHz, 2nd: 450 kHz
- Sensitivity (at 12 dB SINAD) : Less than 0.2 μV
- Squelch sensitivity (threshold) : More than 0.16 μV
- Selectivity : More than 55 dB
- Spurious and image rejection : More than 60 dB
- Intermodulation : More than 55 dB
- Audio output power : More than 0.3 W at 10% distortion with
(at 7.2 V DC) an 8 Ω load
- Ext. speaker connector : 3-conductor 3.5 (d) mm (1/8")/8 Ω

All stated specifications are subject to change without notice or obligation.

Count on us!

A-6552D-1EX
Printed in Japan
© 2006 Icom Inc.

Icom Inc.
1-1-32 Kamiminami, Hirano-ku, Osaka 547-0003, Japan